

SAMSUNG

Instruction Manual

DVD-VR300

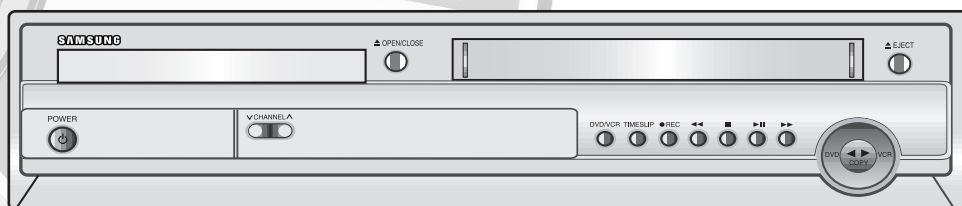

DVD
VIDEO

VHS

Hi-Fi

www.samsung.com

Warning



TO REDUCE THE RISK OF ELECTRIC SHOCK, DO NOT REMOVE THE COVER(OR BACK). NO USER-SERVICEABLE PARTS ARE INSIDE. REFER SERVICING TO QUALIFIED SERVICE PERSONNEL.



This symbol indicates “dangerous voltage” inside the product that presents a risk of electric shock or personal injury.



This symbol indicates important instructions accompanying the product.

Do not install this equipment in a confined space such as a bookcase or similar unit.

WARNING : To prevent damage which may result in fire or electric shock hazard, do not expose this appliance to rain or moisture.

CAUTION : DVD Recorder-VCRS USE AN INVISIBLE LASER BEAM WHICH CAN CAUSE HAZARDOUS RADIATION EXPOSURE IF DIRECTED.
BE SURE TO OPERATE RECORDER CORRECTLY AS INSTRUCTED.

CAUTION

THIS PRODUCT UTILIZES A LASER.
USE OF CONTROLS OR ADJUSTMENTS OR PERFORMANCE OF PROCEDURES OTHER THAN THOSE SPECIFIED HEREIN MAY RESULT IN HAZARDOUS RADIATION EXPOSURE.
DO NOT OPEN COVERS AND DO NOT REPAIR YOURSELF. REFER SERVICING TO QUALIFIED PERSONNEL.

CAUTIONS

Caution: To prevent electric shock, match wide blade of plug to wide slot, fully insert.

Attention: Pour éviter les chocs électriques, introduire la lame la plus large de la fiche dans la borne correspondante de la prise et pousser jusqu'au fond.

This product satisfies FCC regulations when shielded cables and connectors are used to connect the unit to other equipment. To prevent electromagnetic interference with electric appliances, such as radios and televisions, use shielded cables and connectors for connections.

FCC NOTE (for U.S.A):

This equipment has been tested and found to comply with the limits for a Class B digital device, pursuant to

Part 15 of the FCC Rules. These limits are designed to provide reasonable protection against harmful interference in a residential installation. This equipment generates, uses and can radiate radio frequency energy and, if not installed and used in accordance with the instructions, may cause harmful interference to radio communications. However, there is no guarantee that interference will not occur in a particular installation. If this equipment does cause harmful interference to radio or television reception, which can be determined by turning the equipment off and on, the user is encouraged to try to correct the interference by one or more of the following measures:

- Reorient or relocate the receiving antenna.
- Increase the separation between the equipment and receiver.
- Connect the equipment into an outlet on a circuit different from that to which the receiver is connected.
- Consult the dealer or an experienced radio/TV technician for help.



Note

■ This unit can be used only where the power supply is AC 120V, 60Hz. It cannot be used elsewhere.

■ This DVD Recorder-VCR is designed and manufactured to respond to the Region Management Information.

If the Region number of a DVD disc does not correspond to the Region number of this DVD Recorder-VCR, the DVD Recorder-VCR cannot play the disc.

■ This device is protected by U.S. Patent Nos.4,631,603;4,577,216;4,819,098;4,907,093; and 6,516,132. This product incorporates copyright protection technology that is protected by U.S. patents and other intellectual property rights. Use of this copyright protection technology must be authorized by Macrovision, and is intended for home and other limited viewing uses only unless otherwise authorized by Macrovision. Reverse engineering or disassembly is prohibited.

■ This product is covered by one or more of the following U.S. patents:

5,034,830 5,060,200 5,457,669 5,561,649
5,691,858 5,705,762 5,987,417 6,043,912
6,222,983 6,272,096 6,377,524 6,377,531
6,385,587 6,389,569 6,389,570 6,408,408
6,466,532 6,473,736 6,477,501 6,480,829
6,556,520 6,556,521 6,556,522 6,594,208
6,674,697 6,674,957 6,721,493 6,728,474
6,741,535 09/610381 09/610695

DANGER	- VISIBLE AND INVISIBLE LASER RADIATION WHEN OPEN. AVOID DIRECT EXPOSURE TO BEAM.
CAUTION	- VISIBLE AND INVISIBLE LASER RADIATION WHEN OPEN. AVOID EXPOSURE TO BEAM.
ATTENTION	- RAYONNEMENT LASER VISIBLE ET INVISIBLE EN CAS D'OUVERTURE. EXPOSITION DANGEREUSE AU FAISCEAU.
ADVARSEL	- SYNLIG OG USYNLIG LASERSTRÅLING VED ÅBNING. UNNGÅ UDSÆTTELSE FOR STRÅLING.
VARO !	- AVATTAESSA OLET ALTIINNA NÄKYVÄÄ JA NÄKYMÄTÖN LASERSÄTEILYLLE. ÄLÄ KATSO SÄTEESEEN.
VARNING	- SYNLIG OCH OSYNLIG LASERSTRÅLNING NÄR DENNA DEL ÄR ÖPPNAD. BETRAKTA EJ STRÅLEN.
ADVARSEL	- SYNLIG OG OSYNLIG LASERSTRÅLING NÄR DEKSEL ÅPNES. UNNGÅ EKSPONERING FOR STRÅLEN.
VORSICHT	- SICHTBARE UND UNSICHTBARE LASERSTRÄHLUNG, WENN ABDECKUNG GEÖFFNET. NICHT DEM STRAHL AUSSETZEN.
注意	- 打开时有可见及不可见激光辐射。避免激光束照射。
注意	- ここを開くと可視及び不可視のレーザー光が出ます。ビームを直接見たり、触れたりしないでください。

The product unit accompanying this user manual is licensed under certain intellectual property rights of certain third parties. This license is limited to private non-commercial use by end-user consumers for licensed contents. No rights are granted for commercial use. The license does not cover any product unit other than this product unit and the license does not extend to any unlicensed product unit or process conforming to ISO/IEC 11172-3 or ISO/IEC 13818-3 used or sold in combination with this product unit. The license only covers the use of this product unit to encode and/or decode audio files conforming to the ISO/IEC 11172-3 or ISO/IEC 13818-3. No rights are granted under this license for product features or functions that do not conform to the ISO/IEC 11172-3 or ISO/IEC 13818-3.

Precaution



Important Safety Instructions

Read these operating instructions carefully before using the unit. Follow all the safety instructions listed below. Keep these operating instructions handy for future reference.

- 1) Read these instructions.
- 2) Keep these instructions.
- 3) Heed all warnings.
- 4) Follow all instructions.
- 5) Do not use this apparatus near water.
- 6) Clean only with dry cloth.
- 7) Do not block any ventilation openings. Install in accordance with the manufacturer's instructions.
- 8) Do not install near any heat sources such as radiators, heat registers, stoves, or other apparatus (including amplifiers) that produce heat.
- 9) Do not defeat the safety purpose of the polarized or grounding-type plug. A polarized plug has two blades with one wider than the other. A grounding type plug has two blades and a third grounding prong. The wide blade or the third prong are provided for your safety. If the provided plug does not fit into your outlet, consult an electrician for replacement of the obsolete outlet.
- 10) Protect the power cord from being walked on or pinched particularly at plugs, convenience receptacles, and the point where they exit from the apparatus.
- 11) Only use attachments/accessories specified by the manufacturer.
- 12) Use only with the cart, stand, tripod, bracket, or table specified by the manufacturer, or sold with the apparatus. When a cart is used, use caution when moving the cart/apparatus combination to avoid injury from tip-over.
- 13) Unplug this apparatus during lightning storms or when unused for long periods of time.
- 14) Refer all servicing to qualified service personnel. Servicing is required when the apparatus has been damaged in any way, such as power-supply cord or plug is damaged, liquid has been spilled or objects have fallen into the apparatus, the apparatus has been exposed to rain or moisture, does not operate normally, or has been dropped.

Handling Cautions

- Before connecting other components to this recorder, be sure to turn them all off.
- Do not move the recorder while a disc is being played, or the disc may be scratched or broken, and the recorder's internal parts may be damaged.
- Do not put a flower vase filled with water or any small metal objects on the recorder.
- Be careful not to put your hand into the disc tray.
- Do not place anything other than the disc in the disc tray.
- Exterior interference such as lightning and static electricity can affect normal operation of this recorder. If this occurs, turn the recorder off and on again with the POWER button, or disconnect and then reconnect the AC power cord to the AC power outlet. The recorder will operate normally.
- Be sure to remove the disc and turn off the recorder after use.
- Disconnect the AC power cord from the AC outlet when you don't intend to use the recorder for long periods of time.
- Clean the disc by wiping in a straight line from the inside to the outside of the disc.

Maintenance of Cabinet

For safety reasons, be sure to disconnect the AC power cord from the AC outlet.

- Do not use benzene, thinner, or other solvents for cleaning.
- Wipe the cabinet with a soft cloth.

Disc Handling

- Use discs with regular shapes. If an irregular disc (a disc with a special shape) is used, this DVD Recorder-VCR may be damaged.

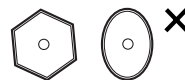

Holding discs

- Avoid touching the surface of a disc where recording is performed.



Cartridge

- This is used to prevent damage by dirt, scratches, etc., when using a DVD-RAM/RW/R disc.

DVD-RAM, DVD-RW and DVD-R

- Clean with an optional DVD-RAM/PD disc cleaner (LFK200DCA1 where available). Do not use cleaners or cloths for CDs to clean DVD-RAM/DVD-RW/DVD-R discs.



DVD-Video, CD

- Wipe off dirt or contamination on the disc with a soft cloth.

Cautions on handling discs

- Do not write on the printed side with a ball-point pen or pencil.
- Do not use record cleaning sprays or antistatic. Also, do not use volatile chemicals, such as benzene or thinner.
- Do not apply labels or stickers to discs. (Do not use discs fixed with exposed tape adhesive or leftover peeled-off stickers.)
- Do not use scratch-proof protectors or covers.
- Do not use discs printed with label printers available on the market.
- Do not load warped or cracked discs.

Disc Storage

Be careful not to harm the disc because the data on these discs is highly vulnerable to the environment.

- Do not keep under direct sunlight.
- Keep in a cool ventilated area.
- Store vertically.
- Keep in a clean protection jacket.
- If you move your DVD Recorder-VCR suddenly from a cold place to a warm place, condensation may generate on the operating parts and lens and cause abnormal disc playback. If this occurs, remove the disc and wait for one to two hours with the power on before attempting playback.

Disc Specifications

DVD-Video

- A digital versatile disc (DVD) can contain up to 135-minutes of images, 8-language audio and 32 subtitle languages. It is equipped with MPEG-2 picture compression and Dolby 3D surround, allowing you to enjoy vivid and clear theater quality images in the comfort of your own home.
- When switching from the first layer to the second layer of a double-layered DVD Video disc, there may be momentary distortion in the image and sound. This is not a malfunction of the unit.
- Once a DVD-R/RW recorded in Video Mode is finalized, it becomes DVD-Video.

Audio CD

- An audio disc on which 44.1kHz PCM Audio is recorded.
- Plays CD-DA format audio CD-R and CD-RW discs. This unit may not be able to play some CD-R or CD-RW discs due to the condition of the recording.

CD-R/RW

MP3 CD-R/RW

- Only CD-R discs with MP3 files recorded with ISO9660 or JOLIET format can be played back
- Only MP3 files with the ".mp3" or ".MP3" extension can be used.
- For MP3 files recorded with a VBR(Variable Bit Rates), from 32 Kbps to 320 Kbps, the sound may cut in out.
- Playable bitrate range is from 56Kbps to 320Kbps.
- The unit can handle a maximum of 1000 files and folders.

JPEG CD-R/RW

- Only JPEG files with the ".jpg", ".JPG" extension can be used.
- The unit can handle a maximum of 1000 files and folders.
- Maximum size of progressive JPEG is 3M pixels.
- MOTION JPEG is not supported.

Using CD-R/RW

- Use a 700MB(80 minutes) CD-R/RW disc. If possible, do not use a 800MB(90 minutes) or above disc, as the disc may not play back.
- If the CD-R/RW disc was not recorded as a closed session, you may experience a delay in the early playback time, and all recorded files may not play.
- Some CD-R/RW discs may not be playable with this unit, depending on the device which was used to burn them. For contents recorded on CD-R/RW media from CDs for your personal use, playability may vary depending on contents and discs.

DVD-R Disc Playback and Recording

- Once a DVD-RW/-R recorded in Video Mode is finalized, it becomes DVD-Video.
- You can record onto the available space on the disc and perform editing functions such as giving titles to discs and programs and erasing programs before finalizing.
- When programming is erased from a DVD-R, that space does not become available. Once an area on a DVD-R is recorded on, that area is no longer available for recording, whether the recording is erased or not.
- It takes about 30 seconds for the unit to complete recording management information after recording finishes.
- This product optimizes the DVD-R for each recording. Optimizing is carried out when you start recording after inserting the disc or turn on the unit. Recording onto the disc may become impossible if optimizing is carried out too many times.

- Playback may be impossible in some cases due to the condition of recording.
- This unit can play back DVD-R discs recorded and finalized with a Samsung DVD video recorder. It may not be able to play some DVD-R discs depending on the disc and the condition of the recording.

DVD-RW Disc Playback and Recording

- Recording and playback can be performed on DVD-RW discs in both Video and VR Modes.
 - Once a DVD-RW recorded in VR Mode is finalized, you cannot perform additional recording.
 - Once a DVD-RW recorded in Video Mode is finalized, it becomes DVD-Video.
 - In both modes, playback can be performed before and after finalization, but additional recording, deleting and editing can not be performed after finalization.
 - If you want to record the disc in VR Mode and then record in V Mode, be sure to execute Format. Be careful when executing Format because all the recorded data may be lost.
 - A DVD-RW blank disc is initialized to VR Mode when first initialized.
- **DVD-RW (VR mode)**
 - This is a format that is used for recording data on a DVD-RAM or DVD-RW disc. You can repeat recording, editing, deleting, partial deletion, creation of playlist, and etc.
 - A disc that is recorded in this mode may not be played by existing DVD players.
 - **DVD-RW (Video mode)**
 - This is a format that is used for recording data on a DVD-RW or DVD-R disc. The disc can be played by an existing DVD player once it has been finalized.
 - If a disc that has been recorded in Video mode by a different manufacturer's recorder but has not been finalized it cannot be played or additionally be recorded by this recorder.

DVD-RAM Disc Playback and Recording

- DVD-RAM discs come with or without a cartridge. For this product, we recommend DVD-RAM discs that come with cartridges.
- Some cartridges are able to eject the disc inside. Even if you are able to eject the disc, always use the disc with the cartridge to ensure correct operation.
- DVD-RAM discs have a Write Protect tab in order to avoid accidental erasure of recorded data. With the Write Protect tab set to PROTECT, you can play the disc, but recording or erasing will not work. Set the Write Protect tab to UNPROTECT to format the disc or erase data.
- Ensure that the recording mode is set to VR mode. Otherwise, this product will not be able to play the recording.

- You cannot play a DVD-RAM in most DVD players due to compatibility issues.
- Only DVD-RAM standard Version 2.0 discs can be played in this unit.
- DVD-RAM recorded on this unit may not work with other DVD Players. To determine compatibility with these DVD-RAM discs, refer to the user's manual for the player.
- This unit is compatible with both non-cartridge and cartridge DVD-RAM, but the write-protect tabs on cartridge-type discs give better protection to your recordings.

Protection

This DVD Recorder-VCR can allow you to protect the contents of your discs, as described below.

- **Cartridge-protected:** With the write-protect tab set in the protect position, the contents of the disc cannot be recorded, edited, or erased.
- **Program-protected:** See page 76 "Locking the title List"
- **Disc-protected:** See page 87 "Disc Protection"

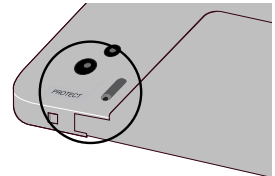

- * DVD-RAM/DVD-RW/DVD-R discs that are incompatible with the DVD-VIDEO format can not be played with this product.
- * For more information on recording a DVD, consult your DVD-RAM/DVD-RW/DVD-R manufacturer.
- * Use of poor quality DVD-RAM/DVD-RW/DVD-R discs may cause following unexpected problems including, without limitation, recording failure, loss of recorded or edited materials or damage to the recorder.

Do not use the following discs!

- LD, CD-G, CD-I, CD-ROM, DVD-ROM, DVD+R and DVD+RW discs should not be used in this product.

[Note]

Disc types that can be played : CD/CD-R/CD RW/ MP3/ JPEG/DVD-Video/DVD-RAM/DVD-RW/ DVD-R.

However, if your DVD-RW disc was recorded with another device, it can be played only if it was recorded and finalized in video mode.

- Some commercial discs and DVD discs purchased outside your region may not be playable with this product. When these discs are played, either "No disc." or "Please check the regional code." will be displayed.
- If your DVD-RW disc is an illegal copy or is not in DVD video format, it may also not be playable.

Contents



◆ Getting Started

Warning	2
Precaution	3
General Features	8
Before Reading the User's Manual	9
How to use the DVD Recorder-VCR	9
Front Panel	11
Front Panel Display	11
Rear Panel	12
Tour of the Remote Control	13

◆ Connecting & Setting Up

Quick Overview	14
Unpacking	15
Connecting the Antenna Cable	15
Connecting the Video Cable	16
Connecting the Audio Cable	18
Connecting External Devices	20
Connecting Power Cord	21
Preparing the Remote Control	21

◆ System Setup

On-Screen Menu Navigation	23
Auto Clock Set	24
Manual Clock Set	25
Channel Set	26

Setting Up the Language Features	27
Setting Up the Audio Options	28
Setting Up the Display (Video) Options	29
Setting Up the Parental Control	30
Auto Channel Memory	31
Channel Add/Delete	32
RF Output Channel	33
VCR Setting	34
Video Input	35
Front Display	36

◆ Playback

*DVD Playback	
Before Playing	37
Playing a Disc	38
Using the Search & Skip Functions	40
Slow Motion Play / Step Motion Play	40
About ANYKEY	41
Repeat Play	42
Using the A-B Repeat Function	43
Moving to a Scene Directly	43
Selecting the Subtitle & Audio Language ..	44
Changing the Camera Angle	45
Using the Bookmark	46
Zooming-In	47
Check Remaining Time	48
Using the Disc and Title menu	48
Playing Back an Audio CD (CDDA)	49
Play Option Mode	50
To Program Tracks	51
Photo CD Playback	52

Playing back MP3 CD	53	Renaming a Title List Entry	74
Using PIP	54	Deleting a Title List Entry	75
*VCR Playback		Locking a Title List Entry	76
Playing the VCR	55	Deleting a Section from a Title List Entry	77
Tracking	55	Creating a Playlist Entry	78
Special VCR Playback Features	56	Editing a Playlist Entry	80
S-VHS Playback	56	Editing Scene for a Playlist Entry	81
Variable Search System	57	Copying a Playlist Entry to the VCR	85
		Deleting a Playlist Entry from the Playlist	85
◆ Recording		Disc Manager	86
*DVD Recording			
Before Recording	58	◆ Reference	
Recording the current channel you are watching	60	Troubleshooting (DVD-VIDEO/DVD-RAM/ DVD-RW/DVD-R)	93
Making a One Touch Recording(OTR)	61	Troubleshooting	94
Making a Timer Recording	61	Problems and Solutions (VCR)	95
Editing Timer Record List	63	Specifications	96
Deleting a Timer Recording Entry	64		
Watching the Images Being Recorded (Time Slip)	65		
Recording From External Devices	65		
Recording through a DV jack	66		
*VCR Recording			
Basic VCR Recording	66		
Special Recording Features	67		
Record Speed	67		
Copy to DVD or VCR	68		
◆ Editing			
Viewing the Menu Functions for a Disc	70		
Viewing Title List	72		
Playing a Title List Entry	73		

General Features



The DVD-VR300 allows you to record and playback high quality digital images on a DVD-RAM/DVD-RW/DVD-R disc. You can also edit digital images on DVD-RAM/DVD-RW discs.

High quality digital audio and video recording and playback

Record up to about 12-hour images with a double side 9.4 GB DVD-RAM disc, and up to about 6-hour images with a 4.7 GB DVD-RAM disc, depending on the recording mode.

Creating DVD video title using DVD-RW/DVD-R disc

With DVD-VR300, create your own DVD video title on 4.7 GB DVD-RW/DVD-R discs.

A Variety of Recording Options

Select an appropriate recording mode between XP, SP, LP and EP to meet your recording needs. (See pages 61~62.)

- XP mode - High quality, about 1 hour
- SP mode - Standard quality, about 2 hours
- LP mode - Low quality, about 4 hours
- EP mode - Lower quality, about 6 hours

Copying digital camcorder content using DV input jack

Record digital camcorder images onto DVD-RAM/DVD RW/DVD-R discs or video tape using the DV input jack (IEEE 1394-4pin). (See page 66.)

Time Slip and Picture In Picture (PIP)

Use the Time Slip function to playback the recorded images while a recording is proceeding (DVD-RAM only).

Use the PIP function to view the playback and recording screens at the same time.

High quality progressive scan

Progressive scanning provides high resolution and flicker free images. The 10-bit 54-MHz DAC, 2D Y/C Separating circuitry and Time Base Corrector processor technology provide you with the highest image playback and recording quality. (See pages 17~18.)

A variety of functions with easy-to-use user interface

Integrated menu system and messaging functionality allow you to perform the desired operations easily and conveniently. With a DVD-RAM/DVD-RW(VR mode) disc, you can edit recorded images, create playlist, and edit images in specific sequence according to your needs.

- * We recommend using one of the discs in the table as they have been confirmed to be compatible with this unit. Discs listed below also may not perform correctly if discs are damaged or have scratches. Other discs may not perform correctly.

Media	Brand	Speed
DVD-R	Apple	4x
	Maxell	4x
	Memorex	4x
	Sony	4x
	TDK	4x
	That's	4x
	Panasonic	4x
	Ritek	4x
DVD-RW	Verbatim	2x
	JVC	2x
	Radius	2x
	TDK	2x
DVD-RAM	MCC Green Non-Ctrg. 4.7G	2x
	MEI White for Video Non-Ctrg. 4.7G	2x
	Fuji Gold Non-Ctrg. 4.7G	2x
	Maxell Ctrg. 4.7G	2x
	TDK White Non-Ctrg. 4.7G	2x
	Memorex Ctrg. 4.7G	2x
	Memorex Ctrg. 9.4G	2x

Disc	No. of maximum recordings by medium
DVD-RAM	100,000
DVD-RW	1,000
DVD-R	1

- * We take no responsibility and offer no compensation for any recording failure, loss of recorded or edited material and/or damage to the recorder arising from usage of unrecommended discs, and take no responsibility and offer no compensation for any subsequent damage caused by above-mentioned problems.









COPY PROTECTION

- Many DVD discs are encoded with copy protection. Because of this, you should only connect your DVD Recorder-VCR directly to your TV, not to a VCR. Connecting to a VCR results in a distorted picture from copy-protected DVD discs.
- This product incorporates copyright protection technology that is protected by methods claims of certain U.S. patents and other intellectual property rights owned by Macrovision Corporation and other rights owners. Use of this copyright protection technology must be authorized by Macrovision Corporation, and is intended for home and other limited viewing uses only unless otherwise authorized by Macrovision Corporation. Reverse engineering or disassembly is prohibited.
- It is permissible to record television programs, film, video tapes and other material only in the event that third party copyrights and other rights are not violated.

Before Reading the User's Manual

Make sure to check the following matters before reading the user's manual.

Icons that will be used in manual

Icon	Term	Definition
	DVD	This involves a function available in DVD or Video Mode DVD-R
	RAM	This involves a function available in DVD-RAM
	RW	This involves a function available in DVD-RW
	R	This involves a function available in DVD-R
	CD	This involves a function available in a data CD (CD-ROM, CD-R, or CD-RW)
	JPEG	This involves a function available in a data picture CD (CD-ROM, CD-R, or CD-RW)
	MP3	This involves a function available in a data CD (CD-ROM, CD-R, or CD-RW on which MP3 is recorded)
	NOTE	This involves tips or instructions on the page that help each function operate
	Preliminary	Check items before operating each function

About the use of this user's manual

- 1) Be sure to be familiar with Safety Instructions before using this product. (See pages 2-5)
- 2) If a problem occurs, check for Troubleshooting. (See pages 93-95)

Copyright

©2004 Samsung Electronics Co.
 All rights reserved; No part or whole of this user's manual may be reproduced or copied without the prior written permission of Samsung Electronics Co.

How to use the DVD Recorder-VCR

Step 1 Select the disc type

This unit can record on the following types of discs. If you want to repeatedly record on the same disc or you want to edit the disc after recording, select a rewritable DVD-RW or DVD-RAM type disc. If you want to save a recording without any changes, choose a non-rewritable DVD-R.



Step 2 Format the disc to start recording

Unlike a VCR, the recorder automatically starts formatting when an unused disc is inserted. This is required for the preparation of recording on a disc.

Using a DVD-RAM

This type of disc can be formatted in DVD-Video Recording format (VR mode). You can edit recorded images and create a playlist in a specific sequence according to your requirements.

Using a DVD-RW

This type of disc can be formatted in either DVD-Video format (Video mode) or DVD-Video Recording format (VR mode). For an unused disc, a message that asks whether to format in VR Mode or not is displayed. You can play a video mode disc on various DVD components. A VR mode disc allows more varied editing.

Using a DVD-R

This type of disc can be formatted in DVD Video format. After formatting is complete, you can record on the disc. You can play this type of disc on various DVD components only when they have been finalized.



- You can only use one format on a DVD-RW.
- You can change the DVD-RW format to another format. It should be noted that the data of the disc may be lost when changing formats.

Step 3 Recording

There are two different recording methods: Direct Recording and Timer Recording. Timer recording is classified as recording type : Once, Daily or Weekly or recording mode : XP (high quality mode), SP (standard quality mode), LP (long recording mode), and EP (extended mode) according to the recording mode.



Step 4 Playing

You can select the title you want to play in a displayed menu and then immediately start playback.

A DVD consists of sections, called titles, and sub sections, called chapters.

During recording, a title is created between two points where you start and stop recording. DVD-R/DVD-RW discs(in Video mode) can automatically create chapters according to the recording mode when finalized.



Step 5 Editing a recorded disc

Editing on discs is easier than conventional video tapes. The recorder supports many different edit functions, possible only with DVDs.

With a simple and easy edit menu, you can operate various edit functions, such as delete, copy, rename, lock, etc., on a recorded title.

Creating a playlist (DVD-RAM/RW in VR mode)

With this recorder, you can create a new playlist on the same disc and edit it without the change of the original recording.



Step 6 Finalizing & Playing on other DVD components

To play your DVD on other DVD components, finalizing may be necessary. First, finish all editing and recording operations, then finalize the disc.

When using a DVD-RW disc in VR Mode

Although finalizing is generally unnecessary when playing the disc on a VR Mode compatible component, a finalized disc should be used for playback on that type of component.

When using a DVD-RW disc in Video Mode

The disc should be finalized first to enable playback on anything other than this recorder. No more editing or recording can be made on the disc once it has been finalized.

To enable recording on the disc again, Disc should be unfinalized.

When using a DVD-R disc

You should finalize the disc to play it on a component other than this recorder. You cannot edit or record on the disc once it has been finalized.

Description

Front Panel

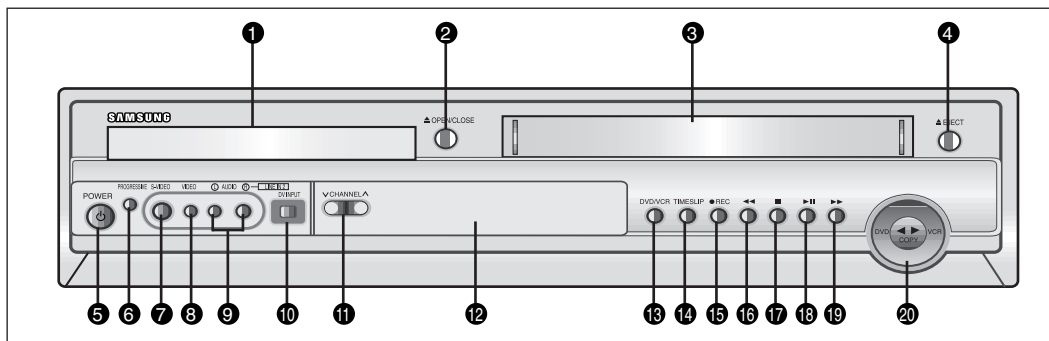

- | | |
|--------------------------|---------------------------|
| 1. DVD DECK | 11. CHANNEL V / ∆ BUTTON |
| 2. DVD OPEN/CLOSE BUTTON | 12. FRONT PANEL DISPLAY |
| 3. VCR DECK | 13. DVD/VCR SELECT BUTTON |
| 4. VCR EJECT BUTTON | 14. TIME SLIP BUTTON |
| 5. POWER BUTTON | 15. RECORD BUTTON |
| 6. PROGRESSIVE BUTTON | 16. REW/SKIP BUTTON |
| 7. S-VIDEO INPUT JACK | 17. STOP BUTTON |
| 8. VIDEO INPUT JACK | 18. PLAY/STILL BUTTON |
| 9. AUDIO L.R INPUT JACK | 19. FF/SKIP BUTTON |
| 10. DV INPUT JACK | 20. COPY BUTTON |

Front Panel Display

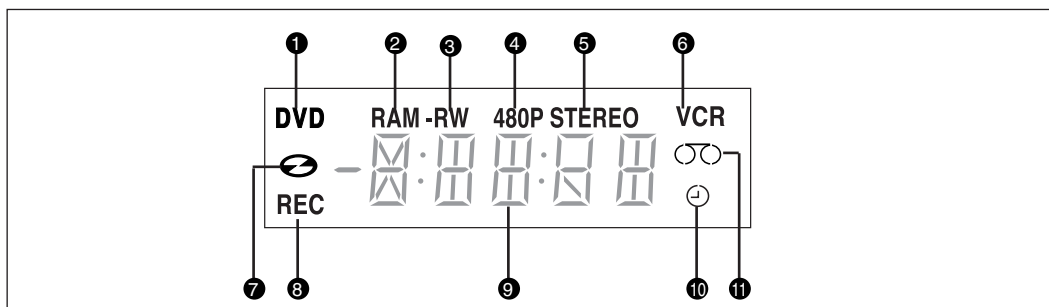

- | | |
|--|--|
| 1. When the indicator is on, DVD is activated. | 7. DVD or CD media is loaded. |
| 2. DVD-RAM is activated. | 8. Record function is working. |
| 3. DVD-R or DVD-RW is activated. | 9. The time, counter position or current deck status is indicated. |
| 4. Progressive Scan mode is working. | 10. When you set a Timer recording, it or current-deck status is indicated. this indicator is lit. |
| 5. When you watch SAP/STEREO channel or playback Hi-Fi VCR tapes, STEREO indicator lights. | 11. VHS Videotape is loaded. |
| 6. VCR is activated. | |

Rear Panel

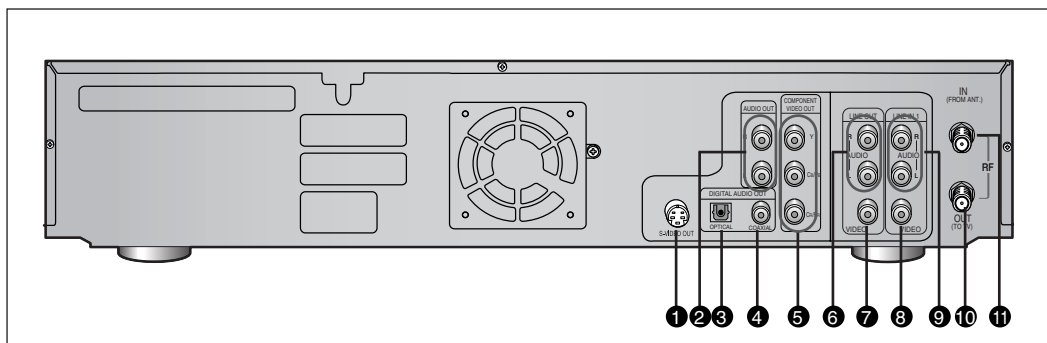

- | | |
|-------------------------------------|---------------------------|
| 1. S-VIDEO OUT JACK | 7. VIDEO OUT JACK |
| 2. AUDIO OUT L,R JACK | 8. VIDEO IN JACK |
| 3. DIGITAL AUDIO OUT JACK (OPTICAL) | 9. AUDIO IN R,L JACK |
| 4. DIGITAL AUDIO OUT JACK (COAXIAL) | 10. RF OUT TO TV JACK |
| 5. COMPONENT VIDEO OUT JACK | 11. RF ANTENNA INPUT JACK |
| 6. AUDIO OUT R,L JACK | |

Tour of the Remote Control

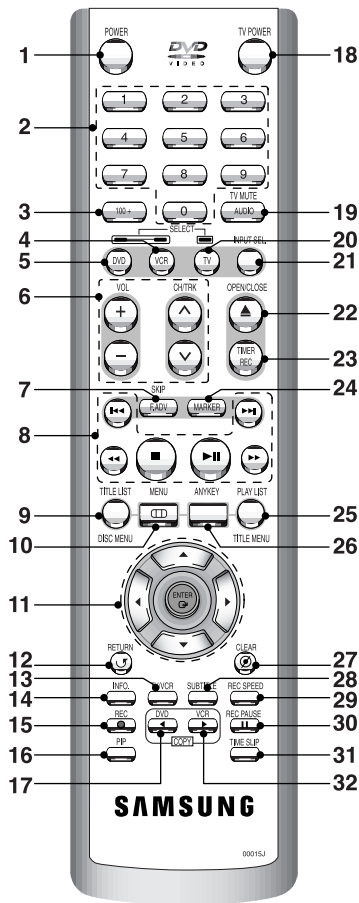

1. **POWER Button**
2. **NUMBER Button**
3. **100+ Button**
Press this to select channel 100 or higher.
4. **VCR Button**
5. **DVD Button**
Press this when you use a DVD.
6. **TV Control Buttons**
 - **VOLUME Button**
TV volume adjustment
 - **CHANNEL Button**
Use this to select a TV channel.
7. **FADV/SKIP Button**
8. **Playback-related Buttons**
Forward/Rewind, Search, Skip, Stop, Play/Pause
9. **TITLE LIST(DISC MENU) Button**
Use this to enter the View Recording list/disk menu.
10. **MENU Button**
Brings up the DVD Recorder-VCR's setup menu.
11. **ENTER/DIRECTION Buttons**
(UP/DOWN or LEFT/RIGHT Buttons)
This button functions as a toggle switch.
12. **RETURN Button**
Returns to a previous menu.
13. **TV/VCR Button**
14. **INFO Button**
This will display current setting or disc status.
15. **REC Button**
Use to make a recording on DVD-RAM/-RW/-R discs.
16. **PIP Button**
Use to watch a subprogram on the PIP screen while watching the main program on the main screen.
17. **DVD COPY Button**
Press this when you copy VCR to DVD.
18. **TV POWER Button**
19. **AUDIO/TV MUTE Button**
Use this to access various audio functions on a disc (DVD mode).
This operates as sound mute. (TV mode)
20. **TV Button**
Press this to operate TV.
21. **INPUT Button**
Select line input signal in external input mode(Tuner or Line input)
22. **OPEN/CLOSE Button**
To open and close the disc tray.
23. **TIMER REC Button**
Press this when you use Timer Recording.
24. **MARKER Button**
Use this to bookmark a position while playing a disc.
25. **PLAY LIST(TITLE MENU) Button**
Use this to return to the Title menu, or to view the recorded files list.
26. **ANYKEY Button**
Use this to view the status of the disc that is being played.
27. **CLEAR Button**
28. **SUBTITLE Button**
Press this to switch the DVD's subtitle language.
29. **REC SPEED Button**
30. **REC PAUSE Button**
Use this to pause during recording.
31. **TIME SLIP Button**
32. **VCR COPY Button**
Press this when you copy DVD to VCR.

Connecting & Setting Up

- **Quick Overview** 14
- **Unpacking** 15
- **Connecting the Antenna Cable** 15
- **Connecting the Video Cable** 16
- **Connecting the Audio Cable** 18
- **Connecting External Devices** 20
- **Connecting the Power Cord** 21
- **Preparing the Remote Control** 21

Quick Overview

A Quick overview presented in this guide will give you enough information to start using the recorder.

Step 1 : Unpacking



Step 2 : Connecting the Antenna Cable



Step 3 : Connecting the Video Cable



Step 4 : Connecting the Audio Cable



Step 5 : Connecting External Devices



Step 6 : Connecting the Power Cord



Step 7 : Preparing the Remote Control

- **Note to CATV system installer** : This reminder is pro-video to call CATV system installer's attention to Article 820-40 of the National Electrical Code (Section 54 of Canadian Electrical Code, Part I), that provides guidelines for proper grounding and, in particular, specifies that the cable ground shall be connected to the grounding system of the building as close to the point of cable entry as practical.

Step 1: Unpacking

Accessories

Check for the supplied accessories below.

- Video/Audio Cable (AC97-01746A)
- RF Cable for TV (AC39-42001J)
- Remote Control (AK59-00015J)
- Batteries for Remote Control (AAA Size) (AC43-12002H)
- User's Manual (AK68-00416A)
- Dispose of batteries according to local environmental regulations. Do not put them in the household trash.

Step 2: Connecting the Antenna Cable

There are several ways to connect your DVD Recorder-VCR. Select one of the following antenna connections that best suits you below.

- Method 1 : Antenna + DVD Recorder-VCR + TV : No Cable box
- Method 2 : Antenna + Cable box + DVD Recorder-VCR + TV : Cable box with many scrambled channels
- Method 3 : Antenna + DVD Recorder-VCR + Cable box + TV : Cable box with a few scrambled channels

-  **Note** ■ If you are using an off-air antenna that has 300-ohm twin flat leads, use an external antenna connector (300-75 ohm adaptor : not supplied) to connect the antenna to the DVD Recorder-VCR.

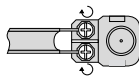

- If you have two separate antennas (one VHF and one UHF), use a UHF/VHF combiner-adaptor (available at most electronics shops) to connect the antenna to the DVD Recorder-VCR.

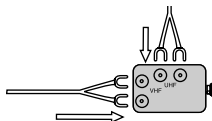

Method 1 : Antenna + DVD Recorder-VCR + TV : No Cable box

You can record non-scrambled channels by selecting the channel on the DVD Recorder-VCR. Also use this Method if you watch channels without cable box.

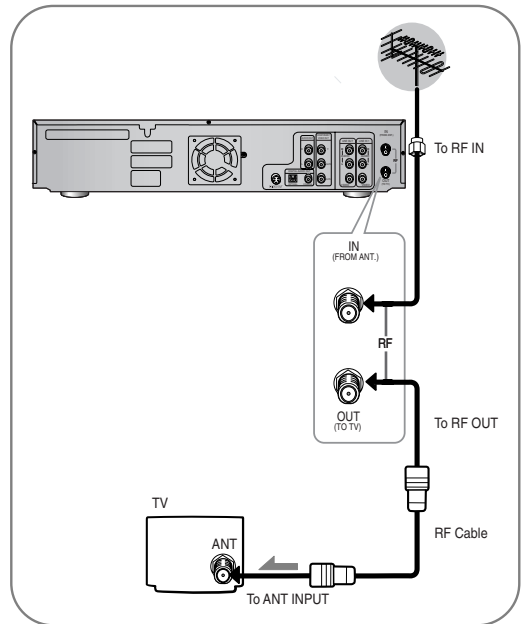

Method 2 : Antenna + Cable box + DVD Recorder-VCR + TV : Cable box with many scrambled channels

You can record channels by selecting the channel on the cable box. You cannot record one channel while watching another channel. Be sure that the cable box is turned on.

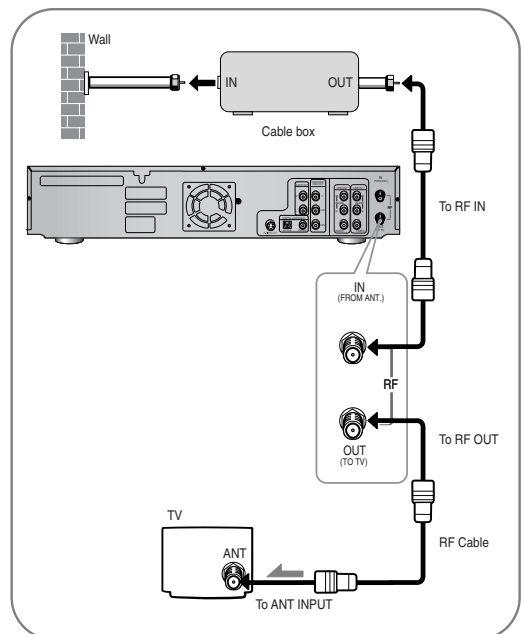

Method 3 : Antenna + DVD Recorder-VCR + Cable box +TV : Cable box with a few scrambled channels

You can record non-scrambled channels by selecting the channel on the cable box. You cannot record scrambled channels that require a cable box.

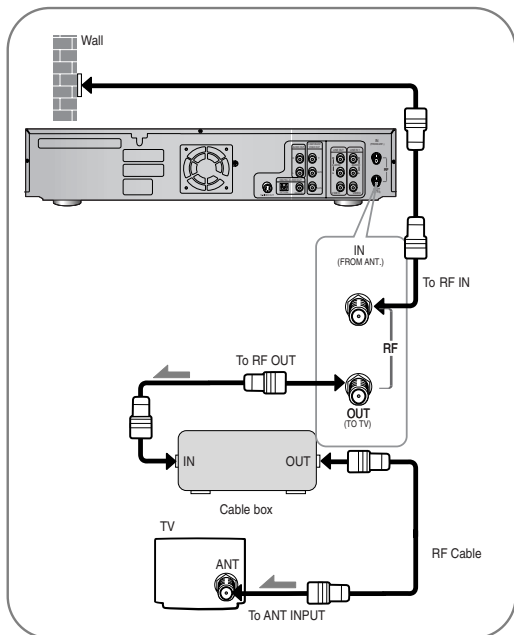

Step 3: Connecting the Video Cable

There are several ways to connect your DVD Recorder-VCR. Select one of the following video connecting methods that best suits you below.

- Method 1 : Connecting to a Video input jack
- Method 2 : Connecting to an S-video input jack
- Method 3 : Connecting to Component video input jacks in 480i mode
- Method 4 : Connecting to Component video input jacks in 480p mode

S-Video, Component video and Progressive Output Modes

- S-Video and Component video output are available only if your TV supports S-Video input or Component video input, respectively. If S-Video or Component video output does not work, check the TV connections and the TV input selection settings.

- Compared to standard interlaced video, progressive scan doubles the amount of video beam lines fed to your TV, resulting in a more stable, flicker-free, and clear image than interlaced video. The progressive scan video output jack is used in progressive output mode. This is only available with TVs that support progressive scan.
- Consumers should note that not all high definition television sets are fully compatible with this product and may cause artifacts to be displayed in the picture. If you experience 525 progressive scan picture problems, it is recommended that you switch the connection to the 'standard definition' output. If there are questions regarding TV set compatibility with this unit, please contact our customer service center at 1-800-SAMSUNG.

Method 1 : Connecting to a video input jack

Connect a video(yellow) cable between the VIDEO (yellow) OUT jack on DVD Recorder-VCR and VIDEO(yellow) IN jack on the TV(or AV amplifier).

- You will enjoy regular quality images.
- Connect audio cables (white and red) between the ANALOG AUDIO OUT jack on the DVD Recorder-VCR and AUDIO IN jack on TV (or AV amplifier).

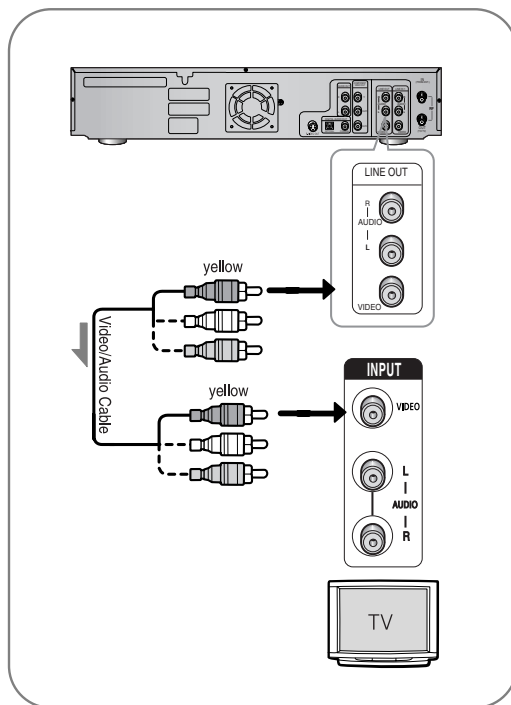

Method 2 : Connecting to an S-video input jack

Connect an S-video cable(not supplied) between the S-VIDEO OUT jack on DVD Recorder-VCR and S-VIDEO IN jack on the TV (or AV amplifier).

- You will enjoy high quality images. S-Video separates the picture element into black and white (Y) and color (C) signals to present clearer images than regular video input mode.

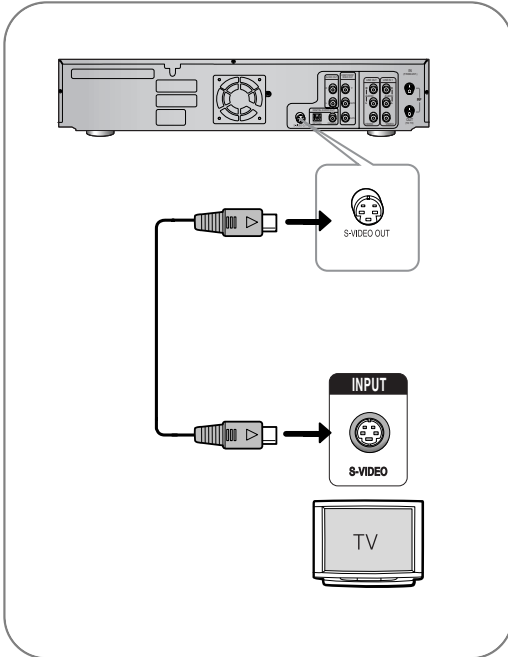

Method 3 : Connecting to Component video input jacks(Y,CB/TB,CR/PB) in 480i mode

1. Connect Component video cables(not supplied) between the COMPONENT VIDEO OUT jacks on DVD Recorder-VCR and COMPONENT VIDEO IN jacks on the TV (or AV amplifier).
2. Make sure that the disc has stopped completely before changing the mode.

If anything is not displayed on front panel display, it is 480i Mode.

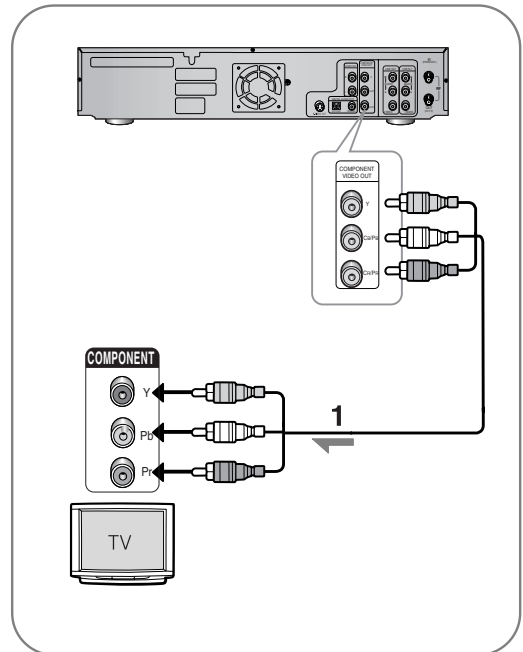

- You will enjoy high quality accurate color reproduction. Component video separates the picture element into black and white (Y), blue (Pb) and red (Pr) signals to present most clear and clean images.



- Make sure that the color coded connections match. The Y, Pb and Pr component output jacks of your DVD Recorder-VCR must be connected to the exact corresponding component input jacks on your TV. Otherwise, red or blue images will be displayed on the TV screen.
- Make sure that the left and right audio output jacks of your DVD Recorder-VCR are connected to the left and right audio input jacks of your TV, respectively.(page 18)

Method 4 : Connecting to Component video input jacks(Y,CB/TB,CR/PB) in 480p mode

Your TV must support progressive scan input to allow you to watch 480p video output.

1. Connect Component video cables(not supplied) between the COMPONENT VIDEO OUT jacks on DVD Recorder-VCR and COMPONENT VIDEO IN jacks on the TV (or AV amplifier).
2. Press the Progressive button on the front panel. The message "Press "Yes" to confirm Progressive scan mode. Otherwise press "No"." will be displayed. If you want 480P mode, select yes. If "480P" is displayed on the front panel display, now your DVD Recorder-VCR is operated on 480P Mode. Make sure that the disc has stopped completely before changing the mode.

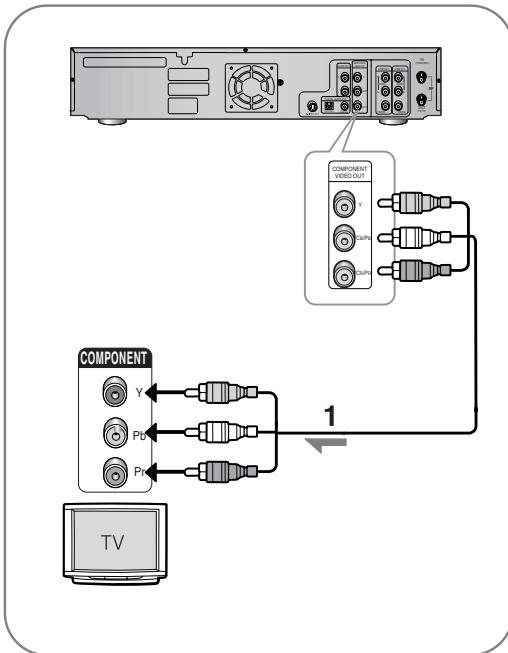

- Make sure that the color coded connections match. That is, the Y, Pb and Pr component output jacks of your DVD Recorder-VCR should be connected to the exact corresponding component input jacks on your TV. Otherwise, red or blue images will be displayed on the TV screen.
- Once 480p video output mode is selected, Video, S-Video and 480i outputs are disabled.
- Make sure that the left and right audio output jacks of your DVD Recorder-VCR are connected to the left and right audio input jacks of your TV, respectively.(page 19)

Step 4 : Connecting the Audio Cable

There are several ways to connect your DVD Recorder-VCR. Select the audio connection that best suits you below.

- Method 1 : Connecting to your TV
- Method 2 : Connecting to a stereo amplifier (analog audio out / digital audio out)
- Method 3 : Connecting to an AV amplifier with a digital input jack.

Manufactured under license from Dolby Laboratories. "Dolby" and the double-D symbol are trademarks of Dolby Laboratories.

"DTS" and "DTS Digital Out" are trademarks of Digital Theater Systems, Inc.

Method 1 : Connecting to your TV

This connection will use your TV's speakers.

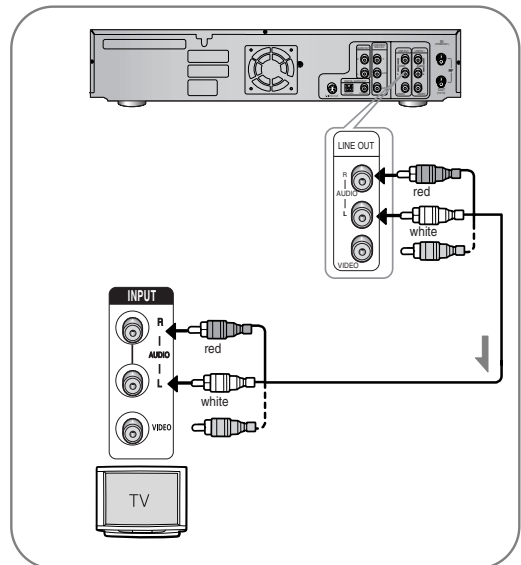

Method 2 : Connecting to a stereo amplifier with analog input jacks

If your stereo amplifier only has audio input jacks (L and R), use the analog audio out jacks.

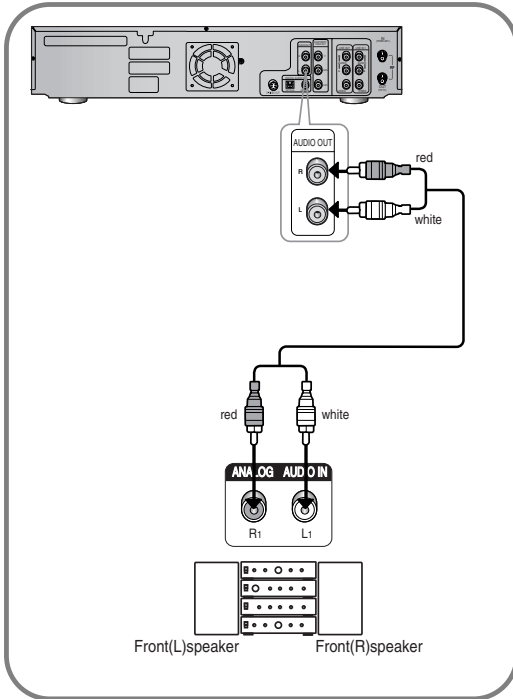

Method 3 : Connecting to an AV amplifier with the digital input jack

If your AV amplifier only has a Dolby Digital or DTS decoder and a digital input jack, use this connection. To enjoy Dolby Digital or DTS sound, you must set up the audio settings. (See page 28)

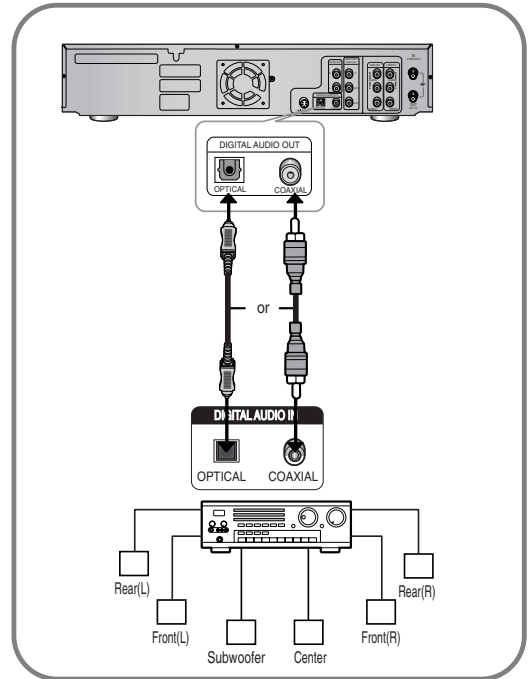

Step 5 : Connecting External Devices

This allows you to connect your DVD Recorder-VCR to other external devices and view or record their outputs.

- Method 1 : Connecting a VCR, Set-Top Box(STB) or DVD player to the AUDIO/VIDEO LINE IN 1 jacks.
- Method 2 : Connecting a Camcorder to the LINE IN 2 in jacks.
- Method 3 : Connecting a Camcorder to the DV IN jack.

Method 1 : Connecting a VCR, Settop Box(STB) or DVD player to the AUDIO/VIDEO LINE IN 1 jacks

Connecting a VCR or external device to AUDIO/VIDEO LINE IN 1 jacks of the DVD Recorder-VCR. You can record from connected equipment (VCR, STB or DVD).

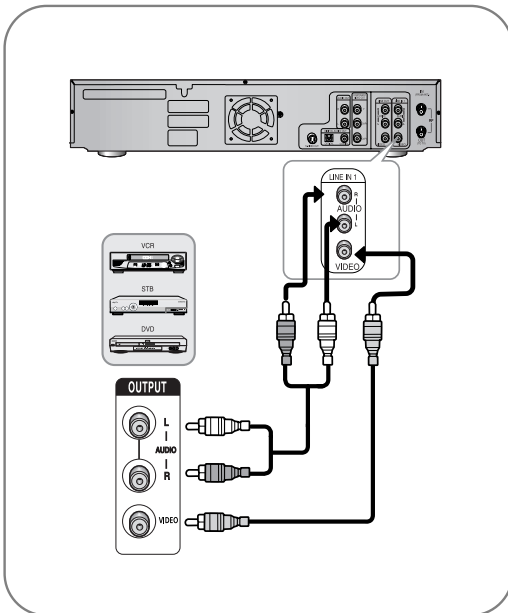

- You can also use the LINE IN 2 jacks on the front panel of the DVD Recorder-VCR.
- When the S-Video jack and Video jack are both connected, the S-Video jack will have priority. Line Selection will be automatically done.
- Copy protected content cannot be recorded.

Method 2 : Connecting a Camcorder to the LINE IN 2 jacks

You can use the LINE IN 2 jacks on the front panel of the DVD Recorder-VCR. You can record from connected equipment.

When an input source is inserted into LINE IN 2 while viewing TV, the input will be switched to LINE IN 2 automatically.

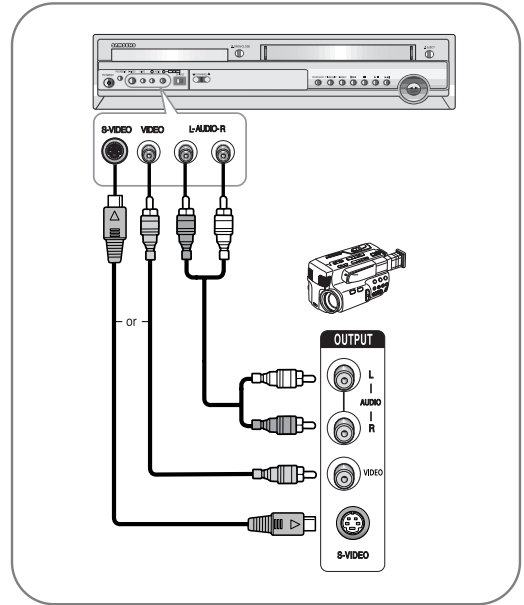

Method 3 : Connecting a Camcorder to the DV IN jack

If your camcorder has a DV output jack, connect it to the DV input jack of your DVD Recorder-VCR.

- If your camcorder has a DV output jack, see page 66 for more information.

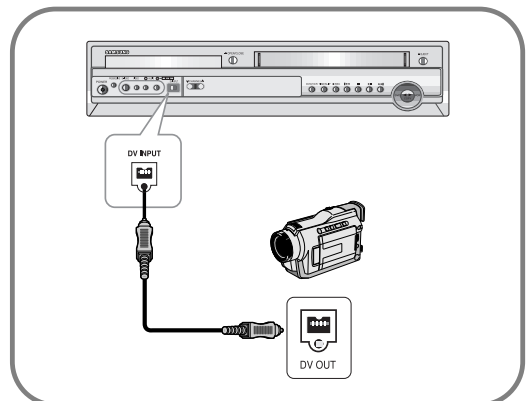

Step 6 : Connecting the Power Cord

After all connections are complete, plug the power cord in the wall outlet.

“AUTO” in the front panel display flickers. This means that the current time is being set automatically (Auto Program) through the antenna under connection. The setup may take several minutes.

When it normally operates, the current time is automatically set and displayed in the front panel display.

If “- - -” appears, however, it means that auto time setting has failed.

In that case, set the current time through the manual clock set, as shown in pages 25~26.

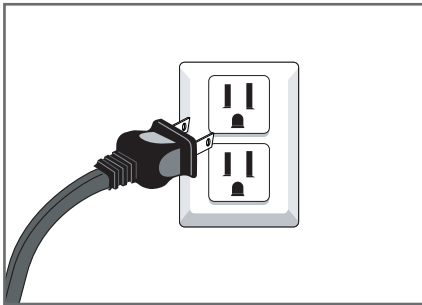

Step 7 : Preparing the Remote Control

Install Batteries in the Remote Control

- Open the battery cover on the back of the remote.
- Insert two AAA batteries. Make sure that the polarities (+ and -) are aligned correctly.
- Replace the battery cover.

If the remote does not operate properly:

- Check the polarity + - of the batteries (Dry-Cell)
- Check if the batteries are drained.
- Check if the remote sensor is blocked by obstacles.
- Check if there is any fluorescent lighting nearby.

Dispose of batteries according to local environmental regulations. Do not put them in the household trash.

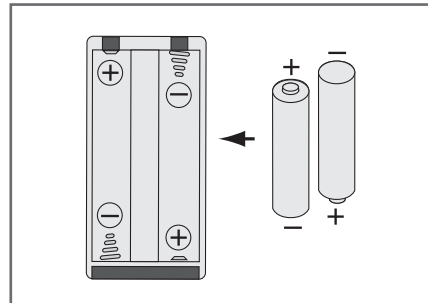

Setting the Remote Control

Your DVD Recorder-VCR remote control will work with Samsung televisions and compatible brands.



To determine whether your television is compatible, follow the instructions below.

1. Switch your television on.
2. Point the remote control towards the television.
3. Hold down the TV button and enter the two-figure code corresponding to the brand of your television, by pressing the appropriate numeric buttons.

Brand	Codes	Brand	Codes
SAMSUNG	01,14,15,23,31	LOEWE	28
SHARP	02,16,22	ZENITH	17
SONY	03	LG	06,08,18
RCA	07,29	MAGNAVOX	04
TOSHIBA	09	EMERSON	21
PANASONIC	12,24	SANYO	05,20
HITACHI	10	DAEWOO	19
NEWSAN	27	NOBLEX	25
JVC	11	TELEFUNKEN	26
MITSUBISHI	13	GRADIENT	30

Result: If your television is compatible with the remote control, it will switch off.
It is now programmed to operate with the remote control.

 **Note** ■ If several codes are indicated for your television brand, try each one in turn until you find one that works.

You can then control the television using the following buttons.

Button	Function
POWER	Used to switch the television on and off.
INPUT SEL.	Used to select an external source.
VOL + or -	Used to adjust the volume of the television.
CH (^ or v)	Used to select the required channel.
TV MUTE	Used to toggle the sound on and off.

 **Note** ■ The various functions will not necessarily work on all televisions. If you encounter problems, operate the television directly.

System Setup

- **On-Screen Menu Navigation** 23
- **Auto Clock Set** 24
- **Manual Clock Set** 25
- **Channel Set** 26
- **Setting Up the Language Features** 27
- **Setting Up the Audio Options** 28
- **Setting Up the Display (Video) Options** . . . 29
- **Setting Up the Parental Control** . . . 30
- **Auto Channel Memory** 31
- **Channel Add/Delete** 32
- **RF Out Channel** 33
- **VCR Setting** 34
- **Video Input** 35
- **Front Display** 36

On-Screen Menu Navigation

The on-screen menus allow you to enable or disable various functions on your DVD Recorder-VCR. Use the following buttons to open and navigate through the on-screen menus.

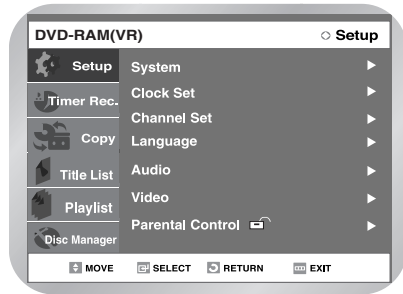

1 MENU Button

Press this button on the remote control while the DVD or VCR is in Stop or Play mode to open the on-screen MAIN MENU.

2 Up/Down and Left/Right

Use these buttons to move the selection bar up/down and left/right to cycle through the menu options.

3 Enter Button

Press this button on the remote control to confirm any new settings.

4 Return Button

Press this button on the remote control to return to the last MENU screen displayed or to exit the on-screen MENU all together.

Auto Clock Set

This menu is used to set the current time. You need to set the time to use timer recording.

- 1 With the unit in Stop mode, press the MENU button.



- 2 Using the ▲▼ buttons, move the selection bar to "Setup" then press Enter to select.

- 3 Select Clock Set using the ▲▼ buttons, then press the ► or ENTER button.



- 4 Select Auto Clock Set using the ▲▼ buttons, then press the ► or ENTER button.

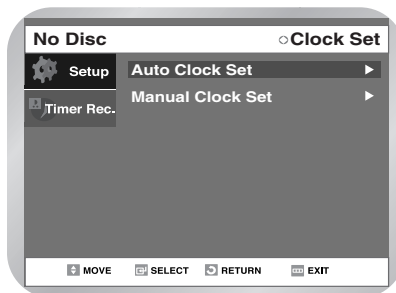

Note

- You must have the antenna connected to set the Auto Clock. See page Antenna Connections
- The Clock will be automatically set when you turn off the recorder.

- 5 Select the sub menu (Clock Data CH, Time Zone or Daylight Saving) using the ▲▼ buttons, then press the ► or ENTER button.

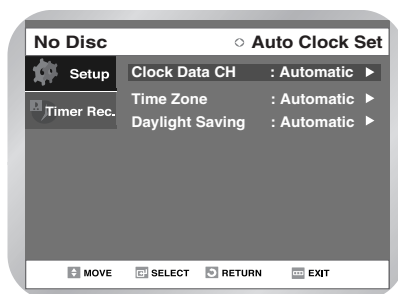

Clock Data CH

Select a channel that carries a time signal using the ▲▼ buttons then press the ► or ENTER button. Select Auto to set the channel automatically.

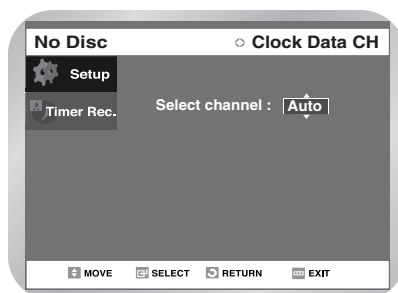

Time ZONE

Select the time zone of your area using the ▲▼ buttons then press the ► or ENTER button. Select Automatic to set the time zone automatically.

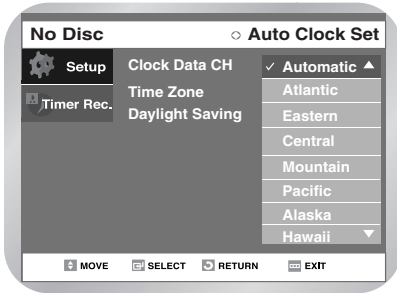

Daylight Saving

Select the On, Off or Auto using the ▲▼ buttons then press the ► or the ENTER button. Select Automatic to set the daylight saving automatically.

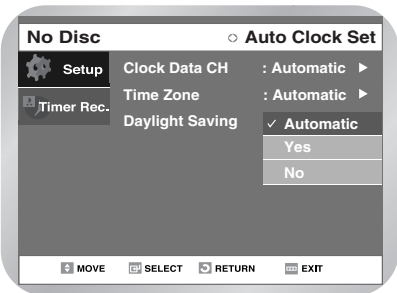

- If your clock is set to the wrong time zone or daylight saving, you can adjust these settings without turning off the Auto Clock Set function.

Manual Clock Set

If Auto Setup fails to set the DVD Recorder-VCR's internal clock by locating a local TV station, follow these steps to set the date and time manually.

NOTE: For accurate Timer Recording, your DVD Recorder-VCR's internal clock must be set correctly.

1 Open "MENU"

Press the MENU button while the DVD or VCR is in Stop or Play mode.

2 Select "Setup"

Using the ▲▼ buttons, move the selection bar to "Setup" then press ENTER to select.

3 Select "Clock Set"

Use the ▲▼ buttons to highlight "Clock Set" then press the ENTER button.

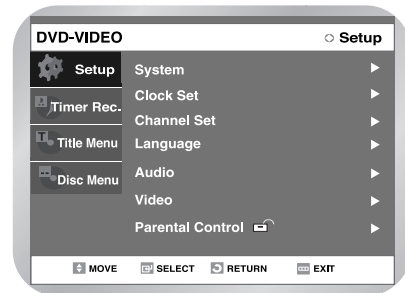

4 Select "Manual Clock Set"

Move the highlight to "Manual Clock Set", then press the ENTER button.

- The Clock Set will change as shown.

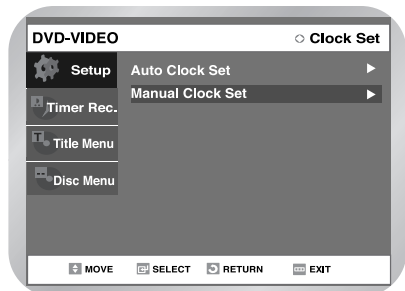

5 Set the Clock

Use the LEFT/RIGHT buttons to select each of the following options, then use the

▲▼ buttons to set each option:

- **Month** – Set the month
- **Day** – Set the day.
- **Year** – Set the year
- **Hour** – Set the hour
- **Minute** – Set the minute
- **AM/PM** – Set the AM/PM

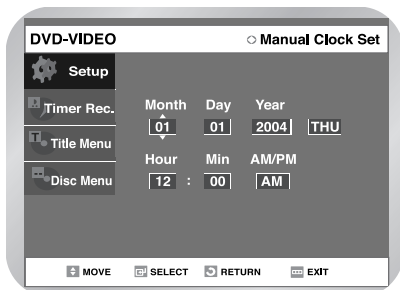

Channel Set

This feature allows you to manually set the DVD Recorder-VCR's tuner band to Antenna or Cable, whichever you connected to the Antenna In jack during initial setup.

- Use this setting only if Auto Setup detected the incorrect tuner band, i.e. channels are coming in on the wrong channel numbers.

1 Open "MENU"

With the DVD in Stop press the MENU button.

2 Select "Setup"

Using the ▲▼ buttons, move the selection bar to "Setup" then press ENTER to select.

3 Select "Channel Set"

Using the ▲▼ buttons, move the selection bar to "Channel Set", then press ENTER to select.

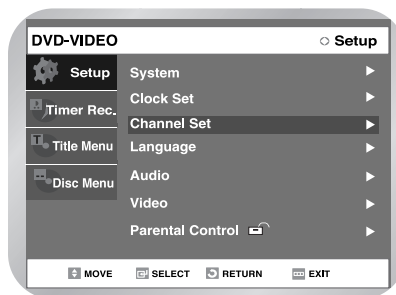

4 Select "Antenna/Cable TV"

Move the selection arrow to "Antenna/Cable TV" then press right button to select from the following options:

- **Antenna** - Select if the DVD Recorder-VCR is connected to an indoor or outdoor VHF/UHF Antenna.
- **Cable TV** - Select if the DVD Recorder-VCR is connected to Cable TV.

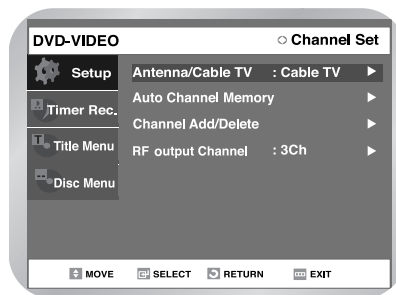

Setting Up the Language Features

If you set the player menu, disc menu, audio and subtitle language in advance, they will come up automatically every time you watch a movie.

1 With the unit in Stop mode, press the MENU button on the remote.

2 Select Setup using ▲▼ buttons, then press the ► or ENTER button.

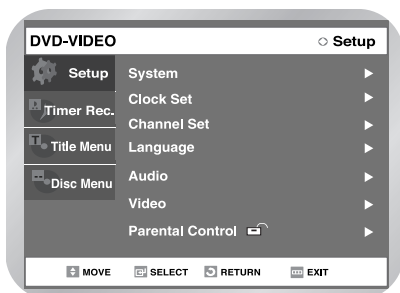

3 Select Language using ▲▼ buttons, then press the ► or ENTER button. Language setup menu will be displayed.

4 Use ▲▼ buttons to select the desired sub menu and press the ENTER or ► button.

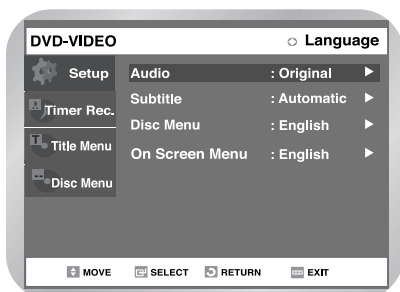

5 Select the desired Language using ▲▼ buttons, then press the ► or ENTER button.

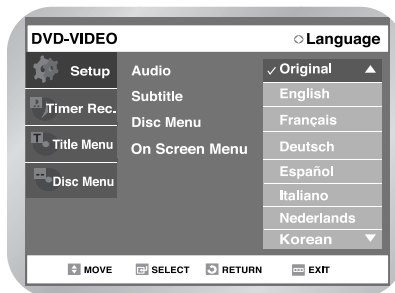

Note ■ Press the RETURN or ◀ button to return to the previous menu. Press the MENU button to exit the menu.

Setting Up the Audio Options

If you set the player menu, disc menu, audio and subtitle language in advance, they will come up automatically every time you watch a movie.

- 1 With the unit in Stop mode, press the MENU button on the remote.

- 2 Select Setup using ▲▼ buttons, then press the ► or ENTER button.

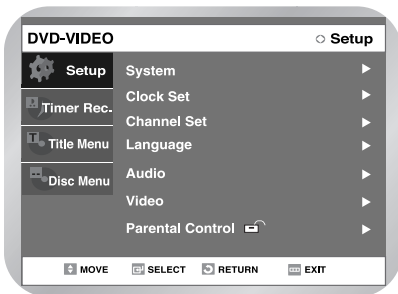

- 3 Select Audio using ▲▼ buttons, then press the ► or ENTER button. Audio setup menu will be displayed.

- 4 Use ▲▼ buttons to select the desired sub menu and press the ENTER or ► button.

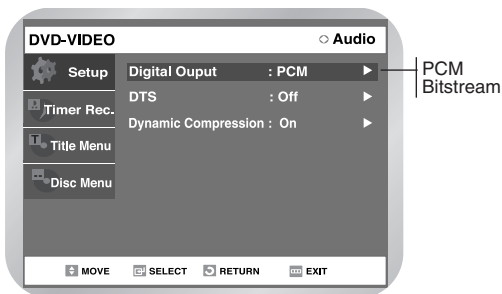

- 5 Use the ▲▼ buttons to select the desired item. Then press the RIGHT or ENTER button.



Note

- Press the RETURN or ◀ button to return to the previous menu. Press the MENU button to exit the menu.

Digital Output

1. PCM : Converts to PCM(2CH) 48kHz audio. Select PCM when using the Analog Audio Outputs.
2. Bitstream : Converts to Dolby Digital Bitstream (5.1CH). Select Bitstream when using the Digital Audio Output.



Note

- Be sure to select the correct Digital Output or no audio will be heard.

DTS

1. Off : Doesn't output digital signal.
2. On : Outputs DTS Bitstream via digital output only. Select DTS when connecting to a DTS Decoder.



Note

- When DTS soundtrack is played, sound is not output from Analog Audio Output.

Dynamic Compression

1. On : To select dynamic compression.
2. Off : To select the standard range.

Setting Up the Display(Video) Options

This function allows you to setup the TV screen settings.

1 With the unit in Stop mode, press the MENU button on the remote.
You can't use the Setup functions during playback.

2 Select Setup using ▲▼ buttons, then press the ► or ENTER button.

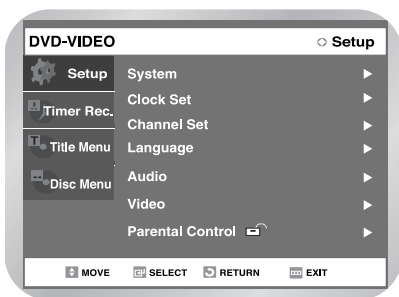

3 Select Video using ▲▼ buttons, then press the ► or ENTER button.
Video option menu will be displayed.

4 Select the sub menu using ▲▼ buttons, then press the ► or ENTER button.

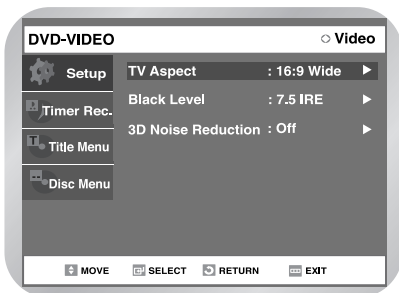

5 Use the ▲▼ buttons to select the desired item.
Then press the RIGHT or ENTER button.

Note ■ Press the RETURN or ◀ button to return to the previous menu. Press the MENU button to exit the menu.

Display(Video) Options

This function depends on disc type. It may not work for some disc types.

TV Aspect

Depending on the type of television you have, you may want to adjust the screen setting. (aspect ratio)

- **4:3 Letter Box** : Select when you want to see the total 16:9 ratio screen DVD supplies, even though you have a TV with a 4:3 ratio screen. Black bars will appear at the top and bottom of the screen.
- **4:3 Pan - Scan** : Select this for conventional size TV when you want to see the central portion of the 16:9 screen. (Extreme left and right side of movie picture will be cut off.)
- **16:9 Wide** : You can view the full 16:9 picture on your widescreen TV.

Black Level

Adjusts the brightness of the screen.

- **0 IRE** : This is the standard NTSC reference black level for consistent brightness/contrast across all source.
- **7.5 IRE** : This will enhance the black level for increased brightness/contrast when viewing DVDs.

3D NR(Noise Reduction)

- **On** : Select to remove noise from the screen
- **Off** : Normal

Setting Up the Parental Control

The Parental Control function works in conjunction with DVDs that have been assigned a rating - which helps you control the types of DVDs that your family watches. There are up to 8 rating levels on a disc.

1 With the unit in Stop mode, press the MENU button on the remote.

2 Select Setup using ▲▼ buttons, then press the ► or ENTER button.

3 Select Parental control using ▲▼ buttons, then press the ► or ENTER button.

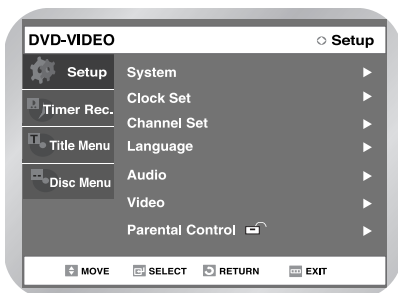

4 Enter the 4-digit password using the 0 to 9 buttons on the remote.

- The 'Confirm the password.' message will be displayed. Enter your password again.

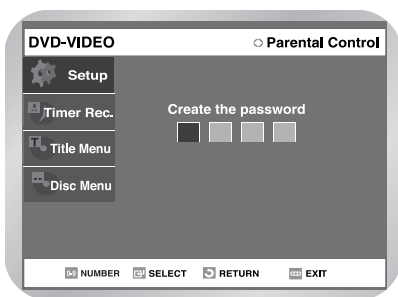

5 Select Password ON/OFF using ► and ▲▼ buttons.

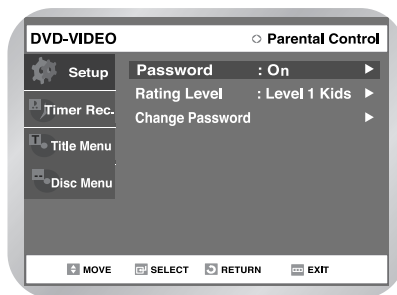
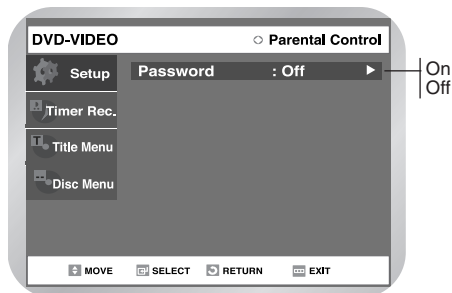

6 Select Rating Level you want using ▲▼ buttons, then press the ► or ENTER button.

- For example, if you select up to Level 6, discs that contain Level 7, 8 will not play. Larger number indicates the program is more intended to adult use only

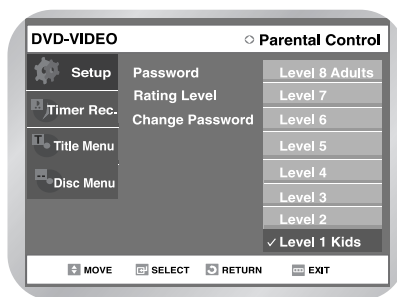

- Note**
- Press the RETURN or ◀ button to return to the previous menu. Press the MENU button to exit the menu.
 - Refer to Troubleshooting if you forget your password.

About the Change Password;

- 1 Select Change Password using ▲▼ buttons, then press the ► or ENTER button.
 - The 'Enter the password.' message will be displayed.
- 2 Enter the 4-digit password using the 0 to 9 buttons on the remote.
 - The 'Confirm the password.' message will be displayed.
- 3 Enter your password again using the 0 to 9 buttons on the remote.



Note

- Press the RETURN or ◀ button to return to the previous menu. Press the MENU button to exit the menu.

Auto Channel Memory

Auto Channel Memory will automatically seek and store all active channels in your area.

- 1 Open "MENU"
With the DVD in stop mode, press the MENU button.
- 2 Select "SETUP"
Using the ▲▼ buttons, move the selection bar to "Setup" then press ENTER to select.

3 Select "Channel Set"

Using the ▲▼ buttons, move the selection bar to "Channel Set", then press ENTER to select.

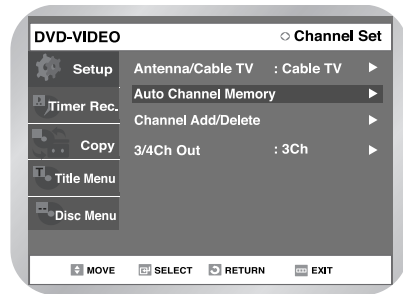

4 Run "Auto channel memory"

Move the selection arrow to "Auto Channel Memory," then press ENTER to select.

- The DVD Recorder-VCR will automatically search for all available channels in the selected Tuner Band. This procedure may take a few minutes to complete.
- When finished, the lowest channel found will be displayed.

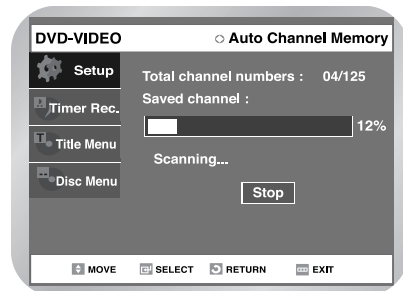

- Press ENTER button to STOP or cancel scanning.

Channel Add/Delete

Use this feature if Auto Channel Search missed a channel that you would like to add and delete a channel you wish to remove.

1 Open "MENU"

With the DVD in stop mode, press the MENU button.

2 Select "Setup"

Using the ▲▼ buttons, move the selection bar to "Setup" then press ENTER to select.

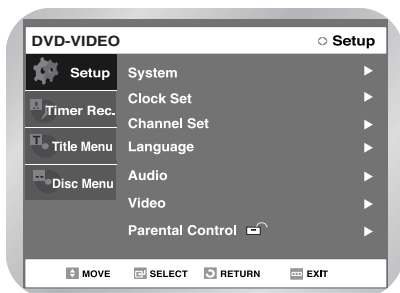

3 Select "Channel Set"

Using the ▲▼ buttons, move the selection bar to "Channel Set", then press Enter to select.

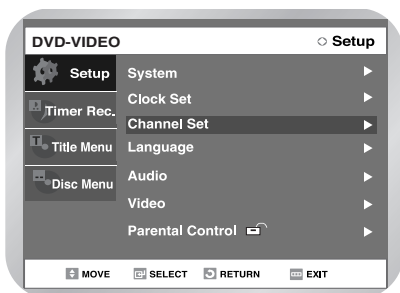

4 Select "Channel Add/Delete"

Move the selection bar to "Channel Add/Delete," then press ENTER to select.

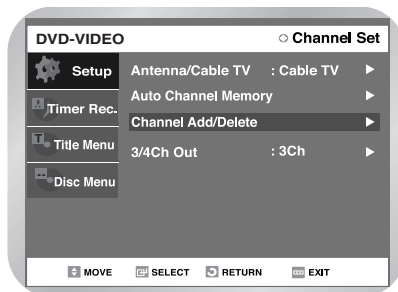

5 Select Channel to Add/Delete

Use the CH ▲/▼ buttons to tune in the channel number you wish to add or delete. Use the number buttons to move the channel directly. If you use the navigation ▲▼ button, the channel will be moved to the next memorized channel.

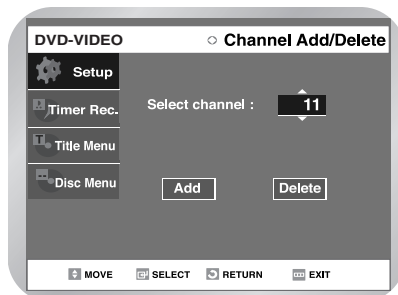

6 Add/Delete Channel.

Press Enter to move the cursor to select Add, then press **▶** if you want to select Delete. Press ENTER to confirm your selection.

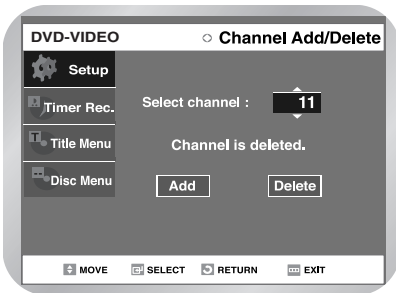
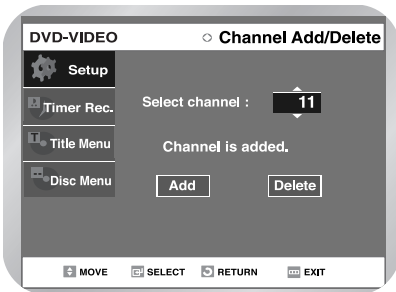

3 Select “Channel Set”

Using the **▲▼** buttons, move the selection bar to “Channel Set,” then press ENTER to select.

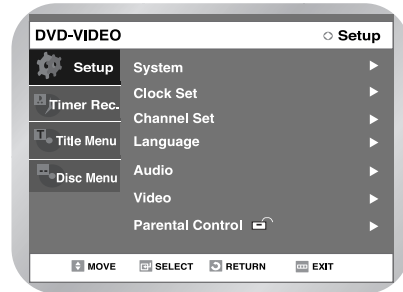

4 Select “RF Output Channel”

Move the selection bar to “RF output Channel”, then press right to change.

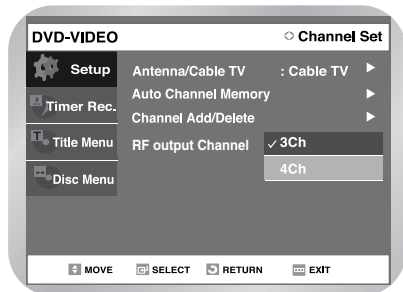

RF Output Channel

When you connect the DVD Recorder-VCR to TV with RF Antenna Cable, follow the steps below to set the RF output channel.

1 Open “MENU”

With the DVD in Stop or Play mode, press the MENU button.

2 Select “Setup”

Using the **▲▼** buttons, move the selection bar to “Setup” then press ENTER to select.

5 Change “RF Output CH”

Select channel 3 or 4 using the **▲▼** button. Then press ENTER to change.

6 Change “TV Channel”

A message will appear on your TV. When the message disappears, change your TV to channel 3 or 4 to match the RF output channel of the player.

VCR Setting

If you want your videotapes to play automatically when you insert them, turn on Auto Play.



- Only tapes that are missing the Record Safety Tab will play automatically when inserted.

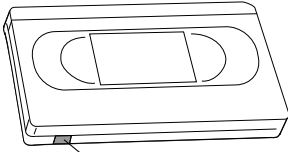

Record Safety Tab

1 Open "MENU"

With the VCR in Stop or Play mode, press the MENU button.

2 Select "Setup"

Using the ▲▼ buttons, move the selection bar to "Setup" then press ENTER to select.

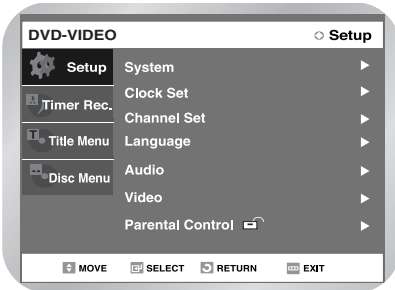

3 Select "System"

Use the ▲▼ buttons to highlight "System" then press the ENTER button.

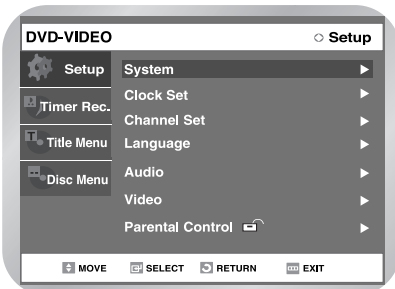

4 Select "VCR"

Using the ▲▼ buttons, move the selection bar to "VCR", then press ENTER to select.

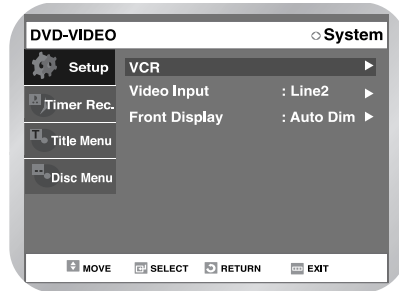

5 Select "Tape Length"

Press the RIGHT button to select the Tape Length. This information is usually printed on the tape box. The menu cycles through: T-120, T-160 or T-180. Once the type of cassette is set, the VCR can display the amount of time remaining on the tape when you press the INFO. button.

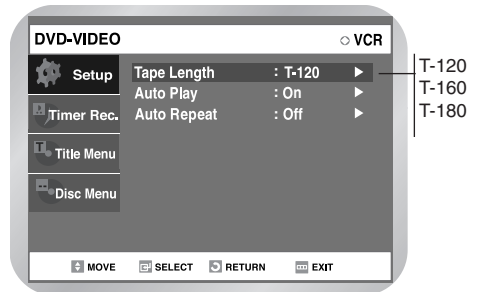

6 Select "Auto Play"

Move the selection bar to "Auto Play," then press right button to select from the following options:

- On - The VCR will automatically begin playing a video tape when it is inserted, as long as the safety tab of the cassette has been removed.
- Off - Auto play is disabled.

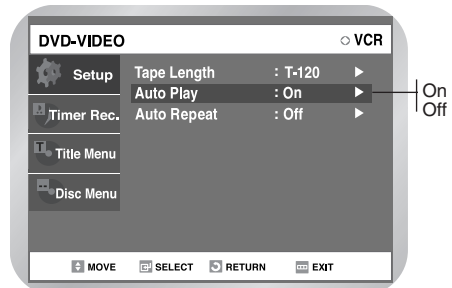

7 Select “Auto Repeat”

Move the selection bar to “Auto Repeat”. It sets the VCR to play a tape repeatedly [unless a tape control is activated (Stop, Fast Forward or Rewind)].

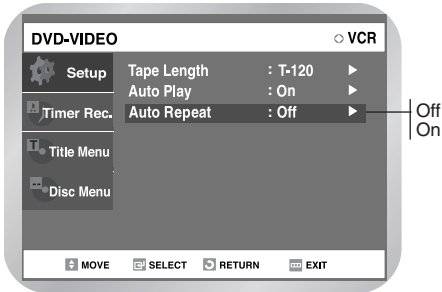

3 Select “System”

Use the ▲▼ buttons to highlight “System” then press the ENTER button.

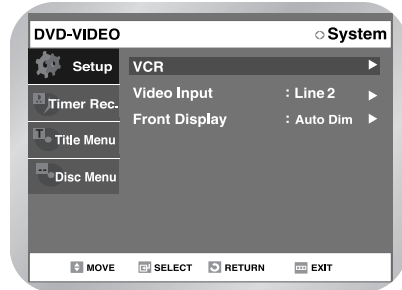

4 Select “Video Input”

Use the ▲▼ buttons to highlight “Video Input”, then press ENTER button and choose Line 2 (Composite) or S-Video.

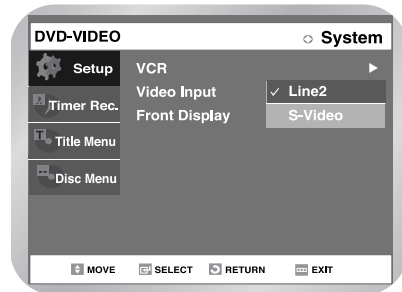

Video Input

If you watch video through Line 2, you can choose Composite or Super(S) video.

1 Open “MENU”

With the DVD Recorder-VCR in stop or play mode, press the MENU button.

2 Select “Setup”

Using the ▲▼ buttons, move the selection bar to “Setup” then press ENTER to select.

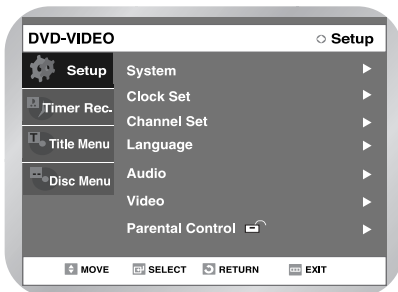

Front Display



You can set the Front Panel Display to be bright all the time, dim all the time, dim during power off.

1 Open “MENU”

With the DVD in Stop or Play mode, press the MENU button. .

2 Select “Setup”

Using the ▲▼ buttons, move the selection bar to “Setup” then press ENTER to select.

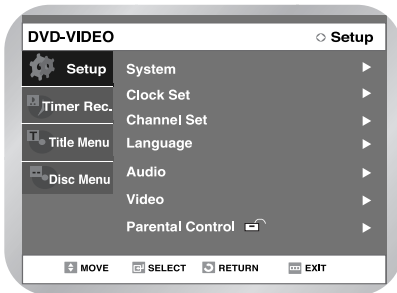

3 Select “System ”

Using the ▲▼ buttons, move the selection bar to “System ” then press ENTER to select.

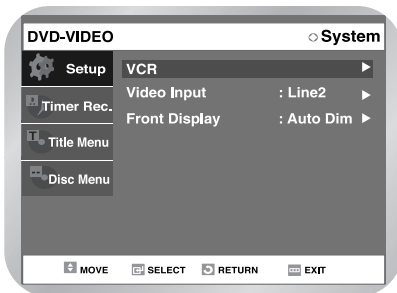

4 Set “Front Display”

Move the selection bar to “Front Display,” then press RIGHT button to select from the following options:

- Auto dim – Front Panel Display will dim automatically during power off.
- Bright – Front Panel Display will be bright all the time.
- Dim – Front Panel Display will be dim all the time.

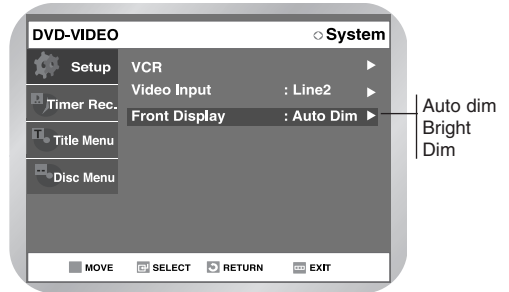

Playback

This section introduces basic functions of playback by disc type.



Dolby Digital



DTS



Digital Audio



Stereo



NTSC broadcast system in U.S.A., Canada, Korea, Japan, etc.



MP3

- **Before Playing** 37
- **Playing a Disc** 38
- **Using the Search & Skip Functions** . 40
- **Slow Motion Play / Step Motion Play** . 40
- **About ANYKEY** 41
- **Repeat Play** 42
- **Using the A-B Repeat Function** 43
- **Moving to a Scene Directly** 43
- **Selecting the Subtitle & Audio Language** 44
- **Changing the Camera Angle** 45
- **Using Bookmark** 46
- **Zooming-In** 47
- **Check Remaining Time** 48
- **Using the Disc and Title menu** . . 48
- **Playing Back an Audio CD (CDDA)** . 49
- **Play Option Mode** 50
- **To Program Tracks** 51
- **Photo CD Playback** 52
- **Playing back an MP3 CD** 53
- **Using PIP** 54
- **Playing the VCR** 55
- **Tracking** 55
- **Special VCR Playback Features** . . 56
- **S-VHS Playback** 56
- **Variable Search System** 57

Before Playing

Preliminary

Read the following information before playing a disc.

Region code (DVD-Video only)



Both the DVD Recorder-VCR and the discs are coded by region. These regional codes must match in order for the disc to play. If the codes do not match, the disc will not play. The Region Number for this DVD Recorder-VCR is described on the rear panel of the DVD Recorder-VCR.

Disc types that can be played

Disc Types	Disc Logo	Recorded content	Disc Shape	Max. Playing Time
DVD-VIDEO		AUDIO + VIDEO	Single sided(5")	about 240
			Double sided(5")	about 480
			Single sided(3.5")	about 80
			Double sided(3.5")	about 160
AUDIO-CD		AUDIO	Single sided(5")	about 74
			Single sided(3.5")	about 20
JPEG CD-R/RW		JPEG Images	Single sided(5")	-
			Single sided(3.5")	-
MP3 CD-R/RW		MP3 Audio	Single sided(5")	-
			Single sided(3.5")	-
DVD-RAM		AUDIO + VIDEO	Single sided (5") (4.7GB)	1(XP: Excellent Quality) 2 (SP: Standard Quality) 4 (LP: Long Playback) 6 (EP: Extended)
			Double sided (5") (9.4GB)	2 (XP: Excellent Quality) 4 (SP: Standard Quality) 8 (LP: Long Playback) 12 (EP: Extended)
DVD-RW		AUDIO + VIDEO	5" (4.7GB)	1 (XP: Excellent Quality) 2 (SP: Standard Quality) 4 (LP: Long Playback) 6 (EP: Extended)
DVD-R		AUDIO + VIDEO	5" (4.7GB)	1 (XP: Excellent Quality) 2 (SP: Standard Quality) 4 (LP: Long Playback) 6 (EP: Extended)

Discs that cannot be played

- DVD-Video with a region number other than “1” or “ALL”
- 3.9 GB DVD-R Disc for Authoring.
- DVD-RAM not recorded following the Video Recording Standard
- Unfinalized DVD-R recorded on other equipment.
- PAL discs
- DVD-ROM/DVD+RW/PD/MV-Disc/DiVX, etc
- Video CD/CVD/SVCD/CD-ROM/CDV/CD-G/CD-I



Note

- This DVD Recorder-VCR can only operate with discs that are compatible with DVD-RAM Standard Version 2.0.
- Playback and/or recording may not work for some types of discs, or when specific operations, such as angle change and aspect ratio adjustment, are being performed. Information about the discs is written in detail on the box. Please refer to this if necessary
- Do not allow the disc to become dirty or scratched, Finger prints, dirt, dust, scratches or deposits of cigarette smoke on the recording surface may make it impossible to use the disc for recording.
- To protect a DVD-RAM disc from damage, use a cartridge.
- DVD-RAM/R/RW discs may not be able to play on some DVD players, depending on the player, disc and the condition of the recording.
- Discs with PAL programs recorded on them cannot be recorded using this product.

Playing a Disc



1 Press the OPEN/CLOSE button.

2 Place a disc gently into the tray with the disc's label facing up.

3 Press OPEN/CLOSE button to close the disc tray.

- Your DVD Recorder-VCR closes the disc tray and plays the disc automatically.
- When a recordable media (DVD-RAM, DVD-RW, DVD-R, etc.) is used, Auto Playback cannot be activated without pressing the Play button. When pressing the Power button while a disc is in the tray, the unit will be activated. Press PLAY to start playback.
- If you insert MP3 Disc, your DVD Recorder-VCR will display the file list on the screen and start.
- When a JPEG disc is inserted, folders and a file list are displayed in the Album format.

4 Press the STOP button to stop playback.



Note

- When you stop disc play, the recorder remembers where you stopped, so when you press PLAY button again, it will pick up where you left off. (unless the disc is removed or the recorder is unplugged, or if you press the STOP button twice.) This function is only applicable to DVD-VIDEO, DVD-RAM, DVD-RW, DVD-R or audio CDs (CD-DA).
-



CAUTION

- Do not move your DVD Recorder-VCR while playing, as this may cause damage to the disc.
 - Make sure to press the OPEN/CLOSE button to open or close the disc tray.
 - Do not push the disc tray while it is being opened or closed, as this may cause a product malfunction.
 - Do not place foreign materials on or in the disc tray.
 - Some functions may perform differently or be disabled depending on the disc type. If this occurs, refer to the instructions written on the disc case.
 - Be especially careful that children's fingers are not caught between the disc tray and the tray chassis when it closes.
 - After turning power on, it will take a few seconds until the DVD operates.
-

Using the Search & Skip Functions

Searching through a Chapter or Track

During play, press the SEARCH ◀◀ or ▶▶ button on the remote control. The playback speed will change as follows.

DVD-VIDEO/ DVD-RAM/DVD-RW DVD-R	PLAY→FF1/FR1→FF2/FR2→ FF3/FR3→FF4/FR4→FF5/FR5→ FF6/FR6
AUDIO CD(CDDA)	PLAY→FF1/FR1→FF2/FR2→ FF3/FR3

- You can scan the program in reverse order. To return to normal speed playback, press the ▶|| button.

Skipping Chapters or Tracks

During play, press the ◀◀ or ▶▶ button on the remote control.

- If you press the ◀◀ button
If you press the ◀◀ button, it moves to the beginning of the chapter or track. Pressing the button once again within 3 seconds returns to the beginning of the previous chapter or track.
- If you press the ▶▶ button
If you press the ▶▶ button, it moves to the next chapter or track.

Skipping ahead 30 seconds

In play mode, press EADV/SKIP button to cue ahead exactly 30 seconds.

Slow Motion Play/ Step Motion Play

Slow Motion Play (DVD-VIDEO/DVD-RAM/DVD RW/ DVD-R)

During pause mode, press the SEARCH ◀◀ or ▶▶ button on the remote for more than 1 second.

- Each time you press the ▶▶ button :
▶▶ Slow X 1/8 →▶▶ Slow X 1/4 →▶▶ Slow X 1/2
- Each time you press the ◀◀ button :
◀◀ Slow X 1/8 →◀◀ Slow X 1/4 →◀◀ Slow X 1/2

To return to normal speed playback, press the ▶|| button.

Step Motion Play (DVD-VIDEO/DVD-RAM/ DVD-RW/ DVD-R)

During pause mode, press the EADV button on the remote.

- Each time the button is pressed, a new frame will appear.

To return to normal speed playback, press the ▶|| button.



Note

- No sound is heard during STEP or SLOW mode.

About ANYKEY



The ANYKEY functions allows you to easily search for a desired scene by accessing title, chapter, track and time. You can also change the subtitle and audio settings and set some features including Repeat, Angle and Zoom.

Press the ANYKEY button on the remote control during playback.

DVD-VIDEO

Title/Chapter/Time/Subtitle/Audio/Repeat/Angle/Zoom

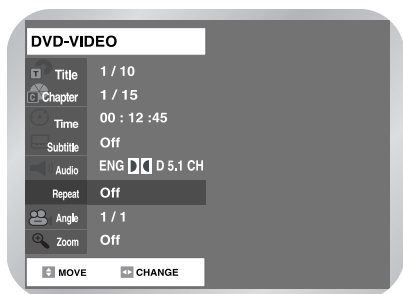

DVD-RAM/DVD-RW

Title/Time/Subtitle/Audio/Repeat/Zoom

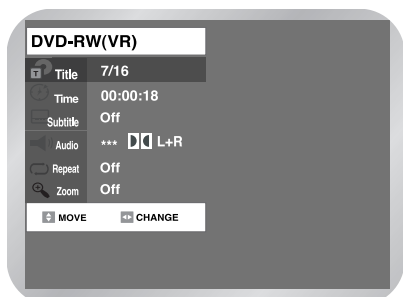

DVD-R

Title/Chapter/Time/Audio/Repeat/Zoom

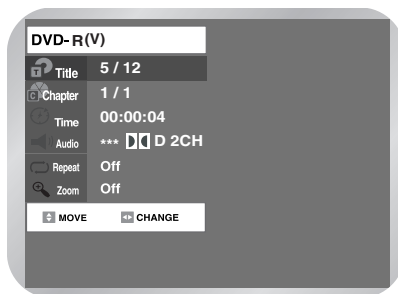

Note

■ What's a track?

A track is usually a song on a Audio CD (CDDA) or MP3 disc.

■ What's a chapter?

A title on a DVD disc is usually divided into chapters.

■ What's a title?

A title means usually a film contained on a DVD disc.

■ This may not work for some discs. When an audio CD(CD-DA) or a MP3 disc is inserted, depending on the type, the information display may not be appear.

■ Regarding the DVD-Video mode, the Time Search function does not operate in some discs.

■ To make the screen disappear, press the ANYKEY again.

Repeat Play



Using Repeat Play (For DVD-VIDEO/DVD-RAM/DVD-RW/DVD-R)

(DVD-VIDEO only supports chapter repeat.)

- 1 Press the ANY KEY button.

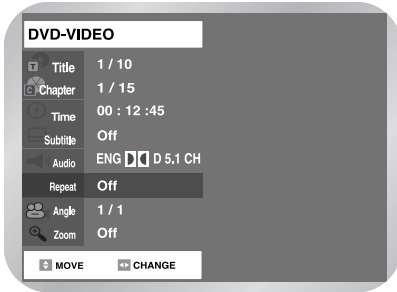

- 2 Use ▲▼ buttons to select Repeat and use ► button to select the Title, Chapter or A-B you want to play repeatedly.

- 3 Press ENTER button.
Repeat play allows you to repeat title, chapter or A-B.
 - To make the screen disappear, press the ANYKEY or RETURN button.

Using Repeat Play (For Audio CD/MP3)

- 1 Press the ANYKEY button during playback.
Repeat is highlighted.

- 2 Press ENTER button.

- 3 Press the ▲▼ button to select the Track or Disc you want to playback repeatedly. For MP3 discs, you can select Track, Folder or Disc.

- 4 Press ENTER button.
Repeat play allows you to repeat a track, folder or the entire disc.

Using the A-B Repeat Function

For DVD-VIDEO/DVD-RAM/ DVD-RW/DVD-R

- 1 Press the ANYKEY button during playback.

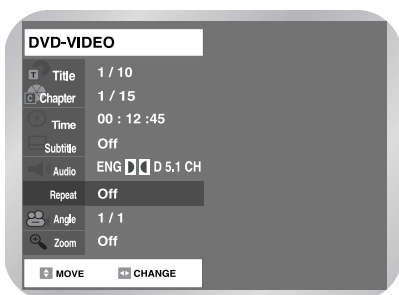

- 2 Use ▲▼ to select Repeat and use ► button to select A-B.

- 3 Press ENTER button.

- 4 Press the ENTER button at the point where you want the repeat play to start (A) and then press the ENTER button at the point where you want the repeat play to Stop (B).

- Your DVD Recorder-VCR will playback the selected section repeatedly.

To return to normal playback

Select Off on the Repeat item or press the CLEAR button on the remote control.

Moving to a Scene Directly

You can find the desired scene easily using the ANYKEY function.

- 1 Press the ANY KEY button during playback.

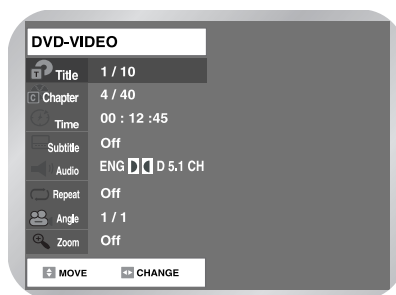

- 2 Use ▲▼ to select the Title, Chapter or time you want to find the desired scene.

- 3 If you want to select a title or chapter, select it using the ◀▶ buttons. Then, press the ENTER button.

- You can enter the desired item directly using the number buttons.

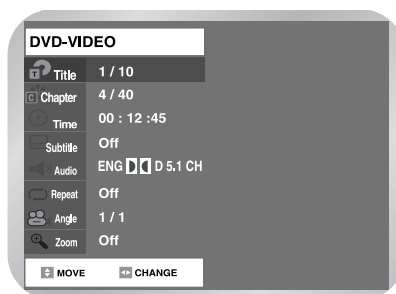

- 4 If you want to move to a desired time, enter the time in the sequence of hour, minute, and second using the number buttons and then press the ENTER button.

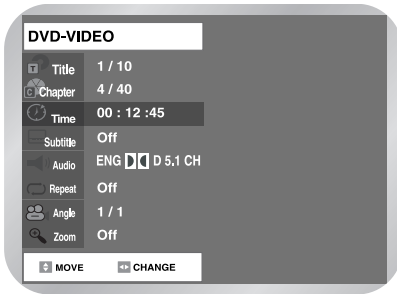

Selecting the Subtitle & Audio Language

Audio languages and subtitle languages may not work depending on disc type.

It is available during playback only.

Selecting the subtitle language

- 1 Press the ANYKEY button during playback.

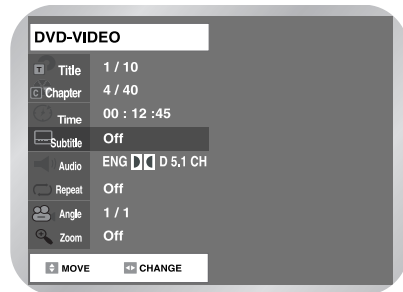

- 2 Use ▲▼ to select Subtitle and use ◀▶ button to select the desired subtitle language.
- If a disc contains subtitles, you can select a desired subtitle language by pressing the ◀▶ buttons.
 - Subtitle display may be different depending on disc type.
 - DVD subtitles may overlap with your TV's subtitles. If this occurs, disable the caption function on your TV.
 - Some discs allow you to select languages from the disc menu only.

Selecting the Audio language

- 1 Press the ANYKEY button during playback.

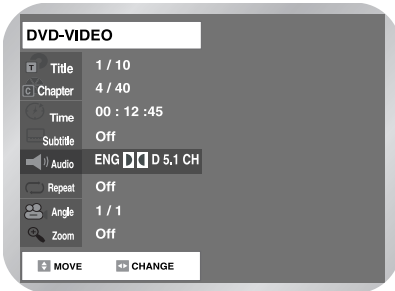

- 2 Use ▲▼ to select Audio and use ◀▶ button to select the desired audio language.

- Audio languages may be different because they are disc-specific.
- Some discs allow you to select languages from the disc menu only.

Changing the Camera Angle

When a DVD contains multiple angles of a particular scene, you can select the Angle function.

- 1 Press the ANGLE button when the "Angle" is shown on the screen during playback.

- 2 Use ▲▼ to select Angle and use ◀▶ button to select the desired angle.

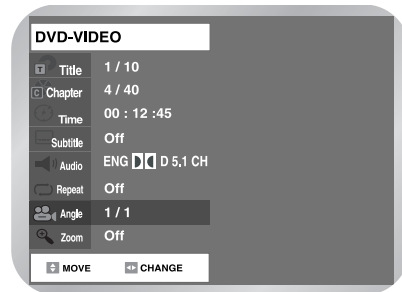

- This function is disc-dependent, and may not work with all DVDs. This function does not work when a DVD has not been recorded with a multi-camera angle system.

Using Bookmarks



Set marks at scenes you want to see again so that you can start playback from the marked position.

Setting a book mark

- 1 Press the MARKER button during playback.

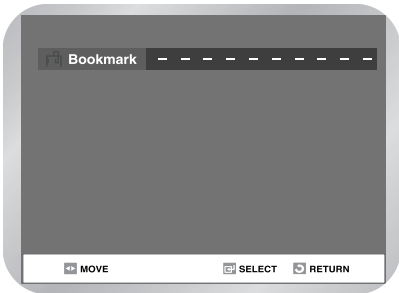

- 2 Press the ENTER button when the desired scene appears.
 - The number 1 is displayed and the scene is memorized.
- 3 Press ► button to move to the next position.
- 4 Press the ENTER button again when the desired scene appears.
 - The number 2 is displayed and the scene is memorized. Repeat above to bookmark other positions. You can bookmark up to 10 scenes.

Bookmarking with DVD-RAM/ DVD-RW(VR) disc

- The screen will display “Marker” in place of “Bookmark” if you are playing a DVD-RAM/DVD-RW(VR).
- Up to 99 scenes can be marked.
- If you press the ENTER button during playback, bookmarks are saved in the order of title.

Playing Back a Bookmark

- 1 Press the MARKER button.
- 2 Press the ◀▶ buttons to select a bookmarked scene.
- 3 Press the ENTER button to start playing from the selected scene.

Clearing a Bookmark

- 1 Press the MARKER button.

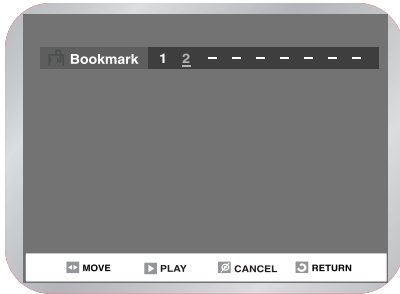

- 2 Press ◀▶ buttons to select a marked scene you want to delete.

- 3 Press Clear button to delete the selected bookmark.

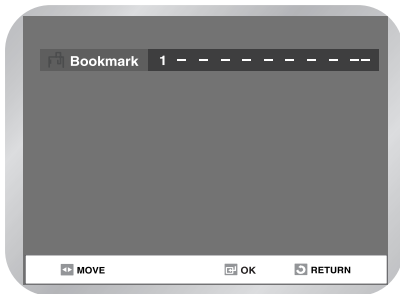

■ When using a DVD-RAM/DVD-RW(VR) the last Marker number added will be deleted.

Zooming-In



- 1 Press the ANY KEY button during playback.

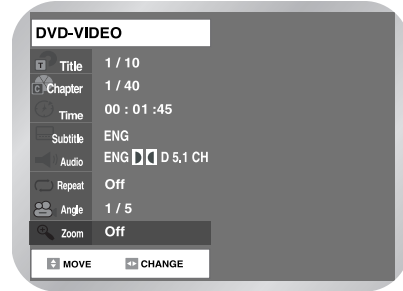

- 2 Use ▲▼ buttons to select Zoom, and then press the ENTER button.
 - 🔍 will be displayed.

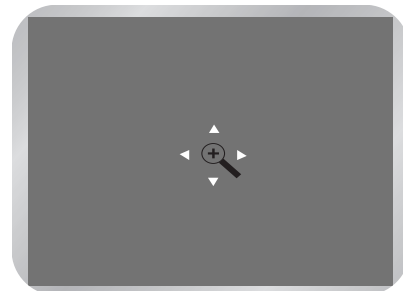

- 3 Press ▲▼◀▶ buttons to move to the area you want to enlarge.

- 4 Press the ENTER button.
 - The screen will be enlarged to twice the normal size.
 - If you press the ENTER button again after the screen was enlarged to twice the normal size, the screen size will be enlarged to four times the normal size.

DVD-VIDEO/ DVD-RAM/DVD-RW/ DVD-R	normal size →2X →4X →2X →normal size
--	---

- 5 To return to the normal size, press the ENTER button repeatedly until the screen becomes of normal size.

Check Remaining Time

- 1 Press Info button on the remote control. Following information will be displayed. (Current deck status, recording speed, remaining time, input channel, current time.)



- 2 Press the TITLE MENU button to move to the title menu of the disc.
 - Use this button if the disc contains more than one title. Some discs may not support the title menu functionality.

For DVD-RAM/DVD-RW/ DVD-R disc

- 1 Press the TITLE LIST button to display title list.



Note

- Title List : Title refers to a recorded video stream. Title List shows list to help you select a title. Since the title list consists of the information on stream that is actually recorded, if one title is deleted, that title cannot be played again.
- Play List : This refers to a unit of playback, which is made by selecting a desired scene in the entire Title List. When one playlist is played, only the scene selected by the user will play and then stop. Since only the information necessary for playing a desired scene is included in a playlist, even if that playlist is deleted, the original data will not be deleted.

Using the Disc and Title Menu

Some type of discs contains a dedicated menu system that allows you to select special functions for title, chapter, audio track, subtitle, film preview, information on characters, etc.

For DVD-VIDEO disc

- 1 Press the DISC MENU button to enter the disc menu of the disc.
 - Move to the setup menu related to playback operation.
 - You can select audio language and subtitle etc. provided by the disc.

Playing Back an Audio CD (CDDA)



Each disc has a variety of menu functions available.

- 1 Insert an audio CD (CDDA) into the disc tray.
 - The audio CD menu appears and the tracks (songs) are played back.

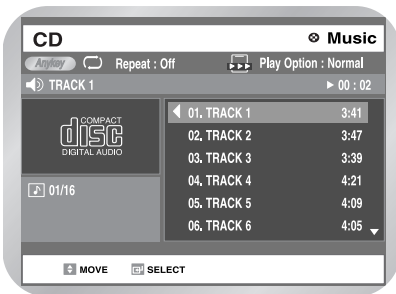

- 2 Press **▲▼** buttons to select the track (song) to start playback from, and then press the ENTER button.
 - You can also select the track (song) by pressing the number buttons on the remote.

Audio CD(CD-DA) Screen Elements

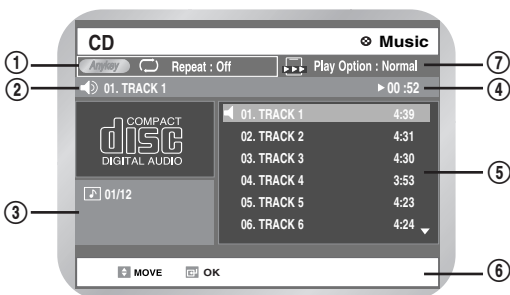

1. Repeat mode: Repeat off/Repeat Track/Repeat Disc.
2. Current track (song): Displays the number of the track currently being played.
3. Displays the current play index and total track number.
4. This shows the operating state of a disc and a playback time corresponding to a portion that is currently played.
5. Displays the track list (song list) and the playing time of each track.
6. Button display.
7. Play Option: Normal, Random, Intro or Playlist

Audio CD (CDDA) Screen Elements

- 1 **▲▼** : Select a track (song).
- 2 **▶** : Playback the selected track (song).
- 3 **ENTER (OK)** button: Playback the selected track (song).
- 4 **▶▶** button: Playback the next track.
- 5 **◀◀** button: Returns to the beginning of the current track when pressed during playback.

If you press this button within three seconds after playback starts, the previous track will be played. If you press this button after three seconds, the current track will be replayed from the beginning.
- 6 Press and hold the **(◀◀/▶▶)** button: Fast Play (FF1/FR1, FF2/FR2, FF3/FR3)

Play Option Mode

- 1 Press the ANYKEY button during playback. Repeat mode will be highlighted.

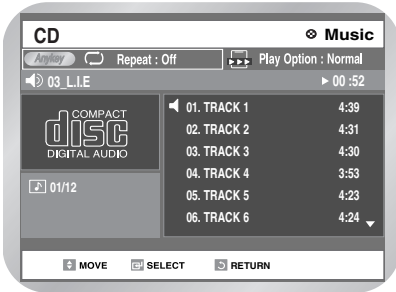

- During Playback, repeat mode will be highlighted.
- During Stop, Play option will be highlighted.

- 2 Select Play Option Mode using the ◀▶ buttons and press the ENTER button.

- The play option screen will appear.

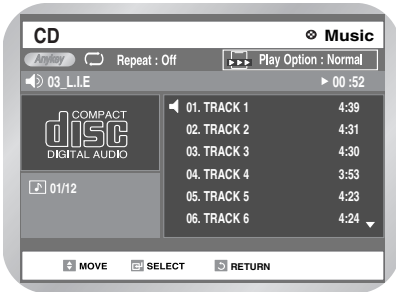

- 3 Select a desired play option using the ▲▼ buttons and press the ENTER button.

- **Normal :** Tracks on a disc are played in the order in which they were recorded on the disc.
- **Random :** The Random option plays a disc's tracks in random order. After a random list is generated and played completely, another random list is generated and played. Random Play continues until the play option is changed.

- **Intro :** The first 10 seconds of each track is played. If you press the ▶|| button during Intro play, Normal Play will be performed from the track currently playing. When Intro Play is completed, Normal Play is performed.
- **Playlist :** The Playlist playback option allows you to select the order in which you want tracks to play.



- The same can be used with a Mp3 disc.



To change repeat mode

- 1 Press ANY KEY during Play to highlight Repeat Mode. Press ENTER when Repeat Mode is highlighted.
- A screen allowing you to change the repeat mode (Off, Disc, Track) will appear.

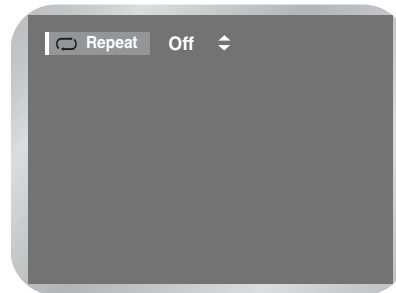

To Program Tracks



You can register a maximum 30 tracks in the playlist.

- 1 Press the ANYKEY button.
Repeat Mode will be highlighted.

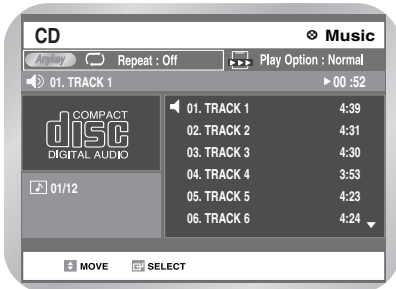

- 2 Select Play Option using the ◀▶ buttons.

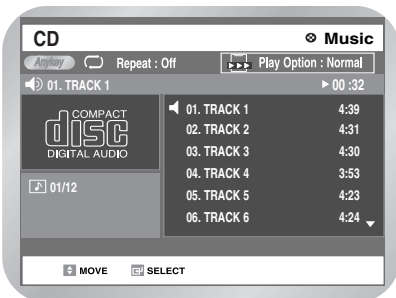

- 3 Press the ENTER button.
The play option screen will appear.
Select Playlist using the ▲▼ buttons.

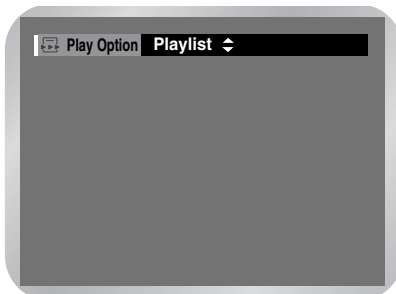

- 4 Press the ENTER button.
The Playlist screen will appear.
Select tracks in the order in which you want them to play using the ▲▼ buttons. Press the ENTER button.

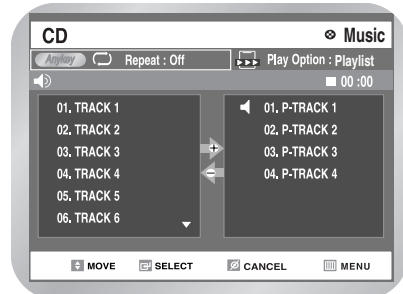

Press the PLAY button to playback playlist.

- 5 If you playlisted a wrong track, select the wrong track using the ▲▼ buttons and press the CLEAR button.
The wrong track will be removed.

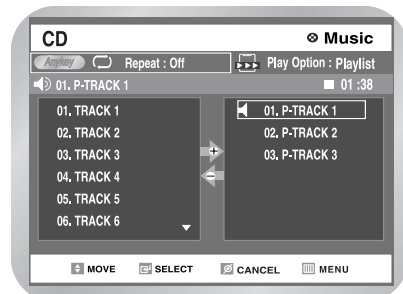
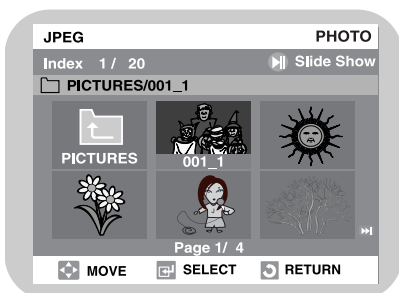

Photo CD Playback

1 Insert a photo CD (JPEG) into the disc tray.

2 The screen shown below will appear automatically.
(Press ►|| button to switch to slide show mode.)



To see the next 6 pictures, press the ►|| button.
To see the previous 6 pictures, press the ◀◀ button.

3 Select Photo using ▲▼ buttons, then press the ENTER button.

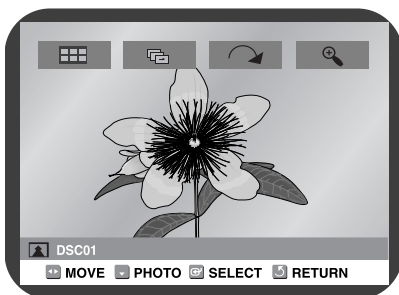

4 Use the ◀▶ buttons to select clips menu and then press the ENTER button.

- ☰ : Returns to the Album screen.
- 🖼️ : The unit enters slide show mode. Before the slide show can begin, the photo interval (slide show speed) must be set
- ↻ : Each time the ENTER button is pressed, the picture rotates 90 degree clockwise.
- 🔍 : Each time ENTER button is pressed, the photo is enlarged up to 4X.
(Normal →2X →4X →2X →Normal)

When using a combination MP3/JPEG disc

1 If you want to listen to MP3 files, but you're currently in Photo mode, press STOP button twice and then press MENU button to bring up the Menu screen.

2 Select Music using the ▲▼ buttons then press the ► or ENTER button. MP3 screen will be shown.

Playing back an MP3 CD

- 1 Insert an MP3 CD into the disc tray.
 - The MP3 menu is displayed and the tracks (songs) are played back.

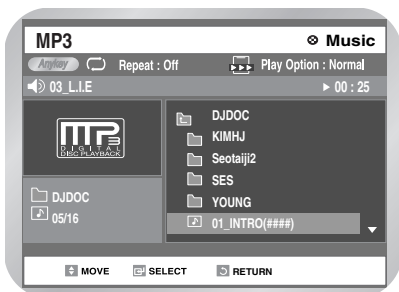

- 2 Press the ▲▼ buttons to select the folder you want to hear, and then press the ENTER button.
 - Press the ▲▼ buttons to select the track (song) you want to hear, and then press the ENTER button.
 - You can also select the desired track (song) by pressing the number buttons on the remote.

Buttons on the Remote

- 1 ▲▼ : Selects a track (song).
- 2 ▶ : Playback the selected track (song).
- 3 ENTER () button:
Plays back the selected track (song) or displays the files in the selected folder.

- 4 RETURN () button:
Moves to the parent of the folder to which the current song belongs.

- 5 (▶▶) button: Plays back the next track.

- 6 (◀◀) button: Returns to the beginning of the current track when it is pressed during playback. If it is pressed again, your DVD Recorder-VCR plays back the previous track.

When using a combination MP3/JPEG disc

- 1 If you want to watch Photo files, but you're currently in MP3 mode, press STOP button twice and then press MENU button to bring up the Menu screen.
- 2 Select Photo using the ▲▼ buttons then press the ▶ or ENTER button. Photo screen will be shown.

Using PIP



The PIP function allows you to view a sub screen together with the main screen in DVD mode.
You can watch both DVD and TV together.



■ PIP does not work in VCR mode.

Note

1

Press the PIP button.

- The current disc is played back on the PIP screen located at the bottom of the screen.

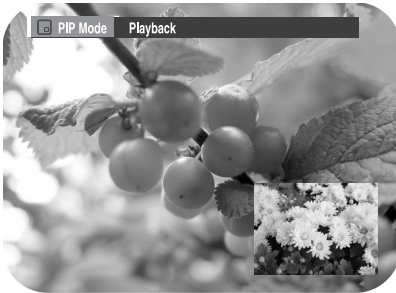

Switching between the PIP and main screens

1

Press the PIP button again.

- The main and PIP screen will be switched.



Deactivating PIP

1

Press the PIP button again.

- PIP will be deactivated.



Playing the VCR

To play a standard VHS videotape, just insert it into the VCR deck and press the PLAY button. You can turn on the Auto Play to enable the VCR deck to play automatically when you insert a videotape that is missing the Record Safety Tab. See pages 34~35.

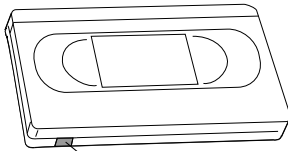

Record Safety Tab

1 Insert VHS Tape

Insert a standard VHS videotape into the VCR deck.

- When a videotape is inserted, power will turn on automatically.

2 Play Tape

Press the ►|| (PLAY/PAUSE) button on the remote control or on the front panel of the unit. The videotape will begin to play automatically if it is missing the Record Safety Tab and Auto Play is turned on. See pages 34~35.

3 Stop Playback

Press the ■ (STOP) button on the remote control or on the front panel of the unit.

Tracking

The Tracking adjustment removes the white lines that sometimes appear during playback because of slight differences in recording decks. The TRK button will automatically align the recorded tracks with the playback heads to solve this problem. You may also set tracking manually.

1 Adjust Tracking Manually

During playback, press the CH/TRK ▲/▼ buttons to remove white lines from the picture.

Special VCR Playback Features

While a videotape is playing, you can enjoy a variety of special playback features, including Still, Frame Advance, Skip, Slow motion, and more. Press the Play button again to resume normal playback.

1 Pause

In Play mode, press ►|| (PLAY/PAUSE) to still a single frame.

2 Frame Advance

In the pause mode, press FADV/SKIP to advance to the next frame.

3 Fps/Review

In Play mode, press Forward (►►) or Rewind (◄◄) to Cue/review at two speeds:

- Picture Search — Press and release to advance the tape forward or backward at 5 times normal speed.
- Jet Search — Press and hold to advance the tape forward or backward at 7 times normal speed.

4 Skip

In Play mode, press FADV/SKIP to cue ahead exactly 30 seconds. Press FADV/SKIP repeatedly up to 4 times to cue ahead 2 minutes.

5 Slow motion

In pause mode, press ►► button for slow motion. Press the press ►► button repeatedly to vary slow motion speed from 1/5 to 1/30 of normal playback. Press the PLAY button twice to resume normal viewing.

S-VHS Playback

The DVD Recorder-VCR allows you to playback high quality S-VHS tapes.

1 Insert a S-VHS Tape

Insert an S-VHS tape into the VCR deck.

2 Start Playback

Press ►|| (PLAY/PAUSE) on the remote control to begin playback of the S-VHS tape.

Variable Search System



Press the ANYKEY button to display the search screen in the stop mode. When a program is recorded, the starting point is given an Index mark for easy location. However, the VHS Index Search System (VISS) cannot recognize index marks made by old VCRs. If the VCR has trouble finding a mark, it is probably because the cassette was recorded on a VCR without VISS. If you want to index two programs in a row, set your VCR to stop, then start recording each program.

1 Go to [0:00:00] stop

Use this feature when you want to search for the [0:00:00] counter position on a cassette. Press the CLEAR button at the point on the tape where you want to set the counter to [0:00:00]. While a cassette is stopped, press the ANYKEY button. The VCR will rewind or fast forward, searching for the [0:00:00] counter position, and then automatically stop at that position.

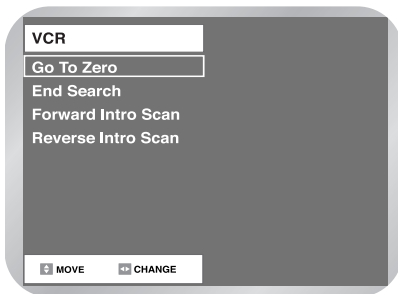

2 End search

Use this feature when you want to search for a blank position to record a program on a cassette. While a cassette is stopped, press the ANYKEY button. The VCR will fast forward, searching for a blank position, and then automatically stop at that position. If the VCR reaches the end of the tape during end search, the tape will be ejected.

3 Scan and play

Use scan and play when you don't know exactly where a program is located on a cassette tape.

- Forward Intro Scan

Highlight "Forward Intro Scan", then press the ENTER button.

- Reverse Intro Scan

Highlight "Reverse Intro Scan", then press the ENTER button.

Recording

This section shows various DVD recording methods.

- **Before Recording** 58
- **Recording the current channel you are watching** 60
- **Making a One Touch Recording (OTR)** 61
- **Making a Timer Recording** 61
- **Editing Timer Record List** 63
- **Deleting a Timer Recording Entry** . . 64
- **Watching the Images Being Recorded (Time Slip)** 65
- **Recording From Other External Devices** 65
- **Recording through a DV Input Jack** . . . 66
- **Basic VCR Recording** 66
- **Special Recording Features** 67
- **Record Speed** 67
- **Copy to DVD or VCR** 68

Before Recording

Preliminary

This unit can record on various types of discs. Before recording, read the following instructions and select the disc type according to your preference.

Recordable discs

This recorder can record on the following discs.

DVD-RAM	DVD-RW	DVD-R
		

- DVD-RWs and DVD-RAMs are rewritable.
- DVD-Rs are non-rewritable.

Compatibility between Samsung Recorder and Other Company's Recorder.

Disc Types	Recording format	Recording Device	Finalizing	Additional Recording in Samsung Recorder
DVD-RAM	VR Mode	Samsung	X	Recordable
		Other Company	X	Recordable
DVD-RW	VR Mode	Samsung	finalized	Not recordable
			not finalized	Recordable
		Other Company	finalized	Not recordable
			not finalized	Recordable
	V Mode	Samsung	finalized	Not recordable
			not finalized	Recordable
Other Company	finalized	Not recordable		
	not finalized	Not recordable		
DVD-R	V Mode	Samsung	finalized	Not recordable
			not finalized	Recordable
			not finalized	Recordable
		Other Company	finalized	Not recordable
			not finalized	Not recordable
			not finalized	Not recordable



Note

- **Finalize**
 - This closes the DVD-R/RW so no additional recording can be done.
- **Unfinalize**
 - This allows additional recording on a finalized DVD-RW disc.
 - A DVD-RW disc that has been recorded by DAO in a PC cannot be unfinalized.
 - A DVD-RW disc that has been recorded in Video Mode of a different maker's recorder cannot be unfinalized.
 - A DVD-R disc cannot be unfinalized.

Recording Formats

When you insert an unused disc, the following message appears. Since available functions differ depending on the disc type, select a disc that best fits your preferences.
DVD-RAM: Use after formatting the disc.



DVD-RW: When unused DVD-RW disc is first inserted, the message "Do you want to initialize this disc" will be displayed. If you select Yes, the disc will be formatted in VR mode. If you want to change the mode, refer to Formatting a Disc on page 88.

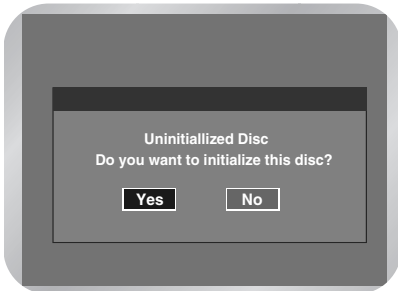

DVD-R: Formatting DVD is unnecessary and only Video Mode Recording is supported.

DVD-RW(Video mode)/-R

- This mode automatically creates chapters at specified intervals during finalization.
- Simple editing (erasing titles/changing title name).

DVD-RW(VR mode)/-RAM

- This mode involves multiple editing functions (such as deletion of a whole title, partial deletion of a title, etc.).
- Various editing options using a created Playlist.

Unrecordable pictures

Pictures with copy protection cannot be recorded on this DVD Recorder-VCR.

When the DVD Recorder-VCR receives a copy guard signal while recording, recording stops and the following message appears on the screen.

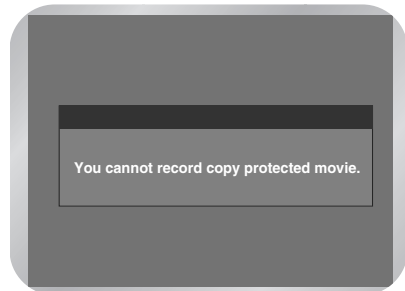

Concerning copy control signals.

Broadcasts that contain copy control signals may have one of the following three signal types, Copy-Free, Copy-Once and Copy-Never. If you want to record a copy-once type program, use DVD-RW with CPRM in VR Mode and DVD-RAM.

	Copy-Free	Copy-Once	Copy-Never
DVD-RW(Ver.1.1)	0	-	
DVD-RW(Ver.1.1) with CPRM			
VR mode	0	0*	
Video mode	0	-	
DVD-R	0	-	
DVD-RAM(Ver.2.0)	0	0*	

Once "Copy Once" has been recorded, additional recording cannot be performed.

This * marked parts are compatible with CPRM.

Recording the current channel you are watching



Preliminary

1. Check the antenna cable is connected.
2. Check the remaining time of disc.
DVD-RAM/DVD-RW discs should be formatted in advance before beginning recording. Most new discs are sold unformatted. Make sure to format your unformatted discs before recording.

1 Press the OPEN/CLOSE button and place a recordable disc on the disc tray.

2 Press the CHANNEL \vee / \wedge button to select the channel you want to record.

3 Press the REC Speed button on remote control, to select the recording speed (quality).

- XP(High, approx. 1 hour) \rightarrow SP(Standard, approx. 2 hours) \rightarrow LP(Low, approx. 4 hours) EP(Extended Play, approx 6 hours)



4 Press the REC button.

- \bullet / \blacksquare is displayed on the screen and recording begins.

5 Press the STOP button to stop or finish a recording in progress.

- The message "Updating the information of disc. Please wait for a moment".

Pausing / Resuming

- Press the REC PAUSE button to pause a recording in progress.
- Press the REC PAUSE button again during pause to resume recording.
- You can switch channels by pressing the CH \vee / \wedge buttons while recording pauses.



Note

- You can't change the recording mode and channel during recording.
- Recording will stop automatically if there is not enough space for recording.
- Up to 99 titles can be recorded onto a disc.
- If the power interrupted due to power failure or other reasons, the title being recorded will not be saved onto the disc.
- Recording will stop automatically if a copy protected image is input.
- Do not use DVD-R authoring discs with this unit.

Making One Touch Recording (OTR)



One-Touch Recording (OTR) allows you to add recording time in 30-minute increments up to 4 hours at the touch of a button.

- 1 Use the channel ∇ / \blacktriangle button or number buttons to select the channel to record.
 - CATV channel: 1 to 125
 - TV channel: 2 to 69

- 2 **Start Recording.**
Follow the instructions on page 60 to begin recording.

- 3 **Activate OTR.**
While in Record mode, press the REC button again to activate One-Touch Recording (OTR).
 - Record length 0:30 appears on the On-Screen Display and the DVD Recorder-VCR will record for exactly 30 minutes.

- 4 **Add Recording Time.**
Continue pressing REC to add recording time in 30 minute increments up to 4 hours.
 - The DVD Recorder-VCR stops recording automatically when the time has elapsed.

Making a Timer Recording



Preliminary

1. Check the antenna cable is connected.
2. Check the remaining time of the disc.
3. Check the date and time are correct.
Make sure the Clock has been set (Setup - System Setting) before you proceed with a timer recording.

- 1 **Press the TIMER REC button.**
 - Scheduled Record List screen is displayed.

Using the MENU button:

- ① Press the MENU button.
 - ② Press the \blacktriangle / \blacktriangledown buttons to select Timer Rec., and then press the ENTER or \blacktriangleright button.
 - ③ Select Timer record.
- If the current time is not set. Set the current time first.

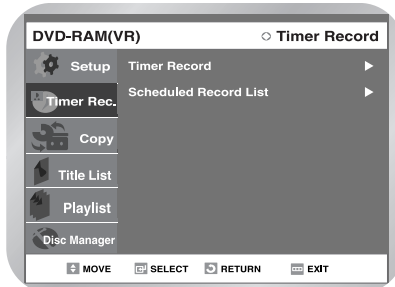

Using the TIMER REC button

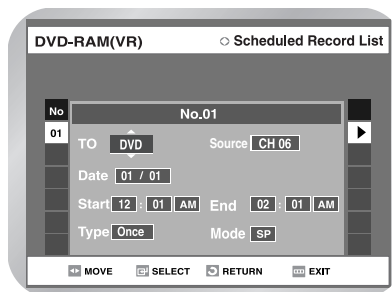

2 Set timer recording option.

- The Timer Recording screen is displayed. Fill the input items using the arrow buttons.

◀▶ : Moves to the previous/next item,

▲▼ : Sets a value.

- **TO** : Select the media to record DVD or VCR.
- **SOURCE** : The video input source (L1 or L2), or the broadcasting channel you want to make a timer recording from.
- **Date** : Set the recording day.
- **Start/End Time** : Start and end time of the timer recording.
- **Type** (Recording cycle).
Once : Records once.
Weekly : Records at a set time every week.
Daily : Records at a set time every day.
- **Mode** (Recording mode).

DVD

AUTO : Select when you want to set video quality automatically. It depends on the remaining time on the DVD.

XP (high quality) : Select when audio and video qualities are important. (Approx. 1 hour)

SP (standard quality) : Select to record in standard quality. (Approx. 2 hours)

LP (low quality) : Select when a long recording time is required. (Approx. 4 hours)

EP (extended mode) : Select when a longer recording time is required. (Approx. 6 hours about 1.2 Mbps)

VCR

AUTO : Select when you want to set video quality automatically. It depends on remaining time of VCR tape.

SP : Standard Play, for best picture quality.

SLP : Super Long Play, for maximum recording time (3 times SP).

3 Press the ENTER button.

-  will appear on the front panel. It means that a timer recording is registered.

If you make a mistake

Press the ◀▶ button to select the item you want to change.

If the timer settings overlap

The programs are recorded in order of priority. If timer recording is set for the first program and then again for the second program and both programs overlap, the following message will appear on the screen: "This setting is identical with 1"
The message shows that the first program has priority. After recording of the first program is complete, the second program starts being recorded.

To exit without saving the current setting

Press the MENU or TIMER REC button.

To return to the previous menu

Press the RETURN button if you don't want to set a timer recording.

4

Turn the power off to finish the timer recording.

-  will blink if disc or tape is not inserted.



Note

- The timer recording time may differ from the set time depending on disc status and overall timer recording status (for example, recording times overlapping, or when the previous recording ends within 2 minutes before the start time of the next recording.)

Editing Timer Record List



Follow these directions to edit the timer record list.

Editing the settings for a timer recording

1 Press the MENU button.

2 Press the ▲▼ button to select Timer Rec., and then press the ENTER or ► button.

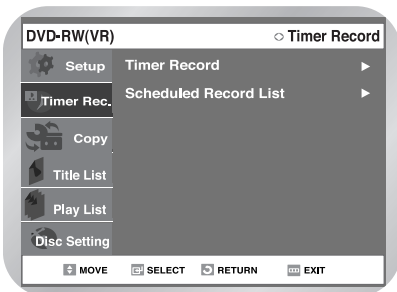

3 Press the ▲▼ button to select scheduled Record List, and then press the ENTER or ► button.

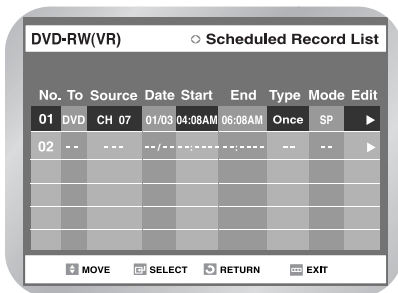

4 Press the ▲▼ button to select the number of the timer recording you want to edit, and then press the ENTER or ► button.

- The Edit and Delete items are displayed.

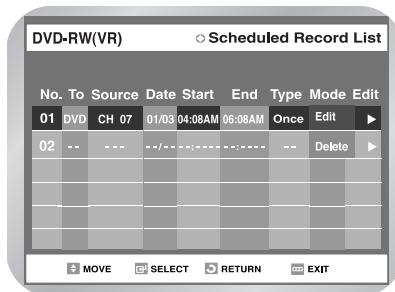

5 Press the ▲▼ button to select Edit, and then press the ENTER button.

- The Timer Recording screen is displayed. Edit the items you want to modify. See the Timer Recording section for more information on Timer Recording Input items.

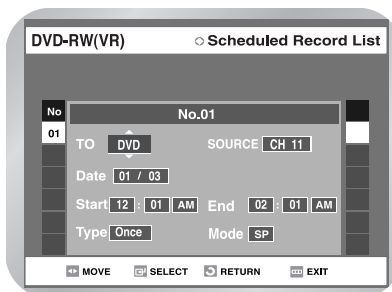

6 Press the ENTER button to confirm the edited setting.

Deleting a Timer Recording Entry



Follow these directions to delete an entry from the timer record list.

1 Press the MENU button.

2 Press the ▲▼ button to select Timer Rec., and then press the ENTER or ► button.

3 Press the ▲▼ button to select scheduled Record List, and then press the ENTER or ► button.

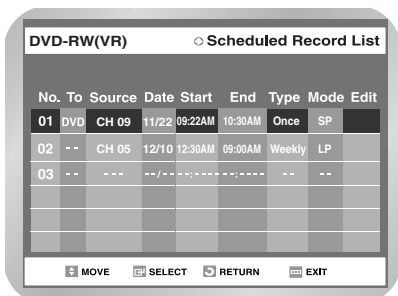

4 Press the ▲▼ button to select the number of the timer recording you want to delete, and then press the ENTER button.

- The Edit and Delete items are displayed.

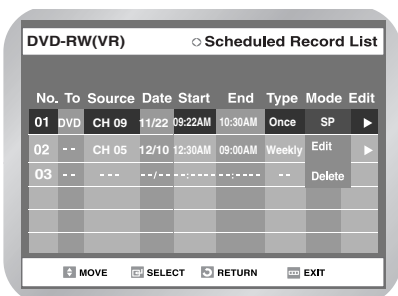

5 Press the ▲▼ button to select Delete, and then press the ENTER button.

- You will be prompted with the delete confirm message such as 'Do you want to delete No.02?'.

6 Press the ◀▶ buttons to select Yes, and then press the ENTER button.

- The selected entry will be deleted from the list.

7 Press the MENU button after finishing the operation. The menu screen will disappear.

Watching the Images Being Recorded (Time Slip)



This function allows you to watch the recently recorded 10-second images on the PIP screen while a recording is in progress.

- 1 Press the TIME SLIP button on the remote control.
 - The recently recorded 10-second images are played back on the PIP screen.
 - This function starts to operate 10 seconds from the time you press the REC button.
 - On the TIME SLIP screen, you can playback, scan, or perform other operations for the recorded program using the playback related buttons. Press the ◀◀ button to scan the recording in the reverse order, from the end to the start. Press the ▶▶ button to scan to the recently recorded 10- second images.

- 2 Press the STOP button once to clear the TIME SLIP function.
 - To stop a recording while a TIME SLIP function is in progress, press the STOP button twice.



Note

- The Time Slip feature only works with DVD-Ram discs.

Recording From External Devices

Follow these directions to record onto a disc or a tape from External Devices.

- 1 Connect the Line out jack of your External Devices to the Line IN jack on the front or rear of your DVD Recorder-VCR using Audio/Video Cable.
- 2 Power on your DVD Recorder-VCR and switch to Line In mode by pressing the INPUT SEL on the remote . The front panel display changes on the following sequence
⤴ Channel Number → L1 → L2 → DV ⤵
- 3 When your DVD Recorder-VCR is in the stop state, set the operation mode of your External Devices to play mode.
- 4 Press the REC button on your DVD Recorder-VCR when the image from which you want to start recording is displayed.
- 5 Press the STOP button on your DVD Recorder-VCR when the recording is finished.



Note

- Also refer to the user manual for your External Devices when recording through Line In mode using Audio/Video cable.

Recording through a DV Input Jack

Follow these directions to record onto a disc or tape the outputs of a camcorder that has a DV output jack.

- 1 Connect the DV output jack of your camcorder to the DV input jack on the front of your DVD Recorder-VCR using a DV cable.
- 2 Power on your DVD Recorder-VCR and switch to DV mode by pressing the INPUT SEL. on the remote.
- 3 With your DVD Recorder-VCR stopped, set the operation mode of your camcorder to play mode.
- 4 Press the ●(REC) button on your DVD Recorder-VCR when the image from which you want to start recording is displayed.
- 5 Press the ■(STOP) button on your DVD Recorder-VCR when the recording is finished.



Note

- Some camcorders may not work with your DVD Recorder-VCR even if they have a DV output jack.
- Also refer to the user manual for your camcorder when recording through a DV jack.

Basic VCR Recording

Preliminary

Before starting

1. Check TV channel and Antenna connections.
2. Check the remaining time on the tape.

You can record a TV show in progress by inserting a blank tape and pressing the ●(REC) button. You can even add time in 30-minute increments up to 4 hours by pressing the ●(REC) button repeatedly; see page 61.



Note

- Be sure your videotape has a Record Safety Tab. If the tab is missing, you can cover the opening with a small piece of tape. Warning: Do not cover this opening unless you are sure you want to record over the tape.

1 Insert Tape

Insert a blank VHS tape into the VCR deck.

- Make sure the tape is long enough to record the entire program.
To change the Recording Speed, see page 67.

2 Select a Channel to Record

Use the 0–9 buttons or the Channel UP/DOWN arrow buttons to select the desired channel, or press the INPUT SEL. button to select Line 1, Line 2 or DV if recording from an external device connected to the front or rear Line inputs, respectively.

3 Start Recording

Press the ●(REC) button on the remote control or front panel.
For options while recording is in progress, see “Special Recording Features”.

4 Pause/Resume Recording

Press the ≡(REC/PAUSE) button.
Press ●(REC) again to resume.

5 Stop Recording

Press the ■(STOP) button.

Special Recording Features

While a recording is in progress, you can watch a different channel, watch a different media, or add recording time in 30-minute increments.

1 Watch a Different Channel

Press the TV/VCR button on the remote to switch to your TV tuner, then select a different channel on your television.

2 Watch a different media during recording

You can watch DVD during VCR recording or watch Video tape during DVD recording.

- During VCR recording, insert a DVD in the DVD deck. The output will automatically change to the DVD and start playback.
- During DVD recording, insert a Video tape in the VCR deck. The output will automatically change to the VCR and start playback. (Only if tape is missing the safety tab)

3 Add Recording Time

Refer to the One-Touch Recording (OTR).

4 Recording DVD and VCR at the same time

You can record DVD and VCR at the same time, but both modes must be set up to record separately.

- Press the DVD/VCR button to set the unit to DVD or VCR mode.
- Choose Line input mode (Ch, Line1, Line2 or DV) for DVD or VCR.
- Choose REC mode for DVD or VCR.
- Press REC button for DVD or VCR.



- When DVD Recorder-VCR is connected to TV using S-Video or component video cable, the playback screen on the video tape will not display during DVD recording.
- You cannot record different channel at the same time.
- The DVD and VCR cannot start recording at the exact same time. You must set one mode to start recording, then the other.

Record Speed

You can slow down the recording speed from SP to SLP in order to fit six hours of programming on a T-120 tape.

1 Start Recording

Follow the Basic Recording instructions on page 66.

2 Set Record Speed

Press the REC SPEED button on the remote control to set the Record Speed to one of the following options:

- SP – Standard Play, for best picture quality.
- SLP – Super Long Play, for maximum recording time (3 times SP).



- The selected Record Speed will appear on the front panel display and on-screen display.

Maximum Recording Time - SP vs. SLP

Tape Length	SP (Standard Play)	SLP (Super Long Play)
T-120	2 hrs	6 hrs
T-160	2hrs 40 mins	8 hrs
T-180	3 hrs	9 hrs



- When you watch or record on the VCR during DVD Recording, some function buttons may not operate. The message “This function is not available.” will be displayed.

Copy to DVD or VCR



You can copy DVD to VCR or VCR to DVD.
Press MENU button and select Copy.

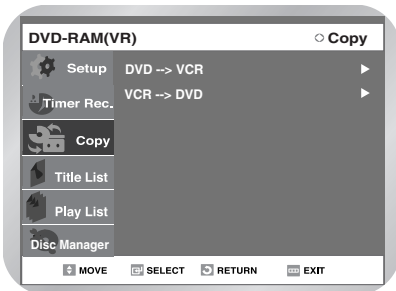

DVD to VCR

1 Select DVD → VCR to copy DVD to VCR.

- Check the remaining time on the tape.

2 If you want to copy from the Copylist, choose “Edit Copylist”.

- To copy from “Edit Copylist”, you need to make a Copylist. To make and select a “New Copylist” (See pages 78–79).
- If you want to copy directly, choose “Direct Copy”.

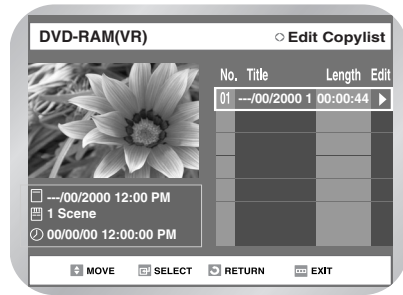
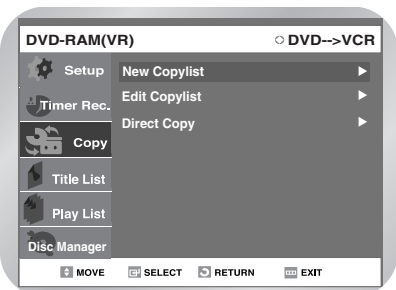

3 Select the Copylist, you want to copy

using the ▲▼ buttons and then press ► button.
To copy play list, select “Copy”.

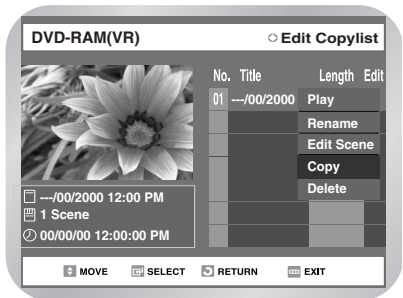

Direct copy DVD to VCR

1 Insert DVD disc you want to copy.

2 Insert VHS tape.

3 Press VCR copy button on front panel or remote control.

4 To stop recording press the stop button.

- You can only use the Direct Copy feature on DVD-R and DVD-RW(V) discs.

VCR to DVD

1 Select VCR -> DVD to copy VCR to DVD.

VCR -> DVD scene will be displayed.

- Check the remaining time on the disc.

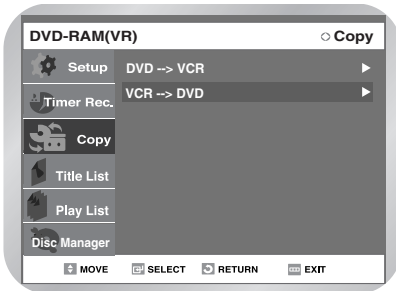

2 Press ENTER button to select the start position.

You can use ►||, ◀◀ or ►►, ◀◀ or ►► buttons to search for the Start position.

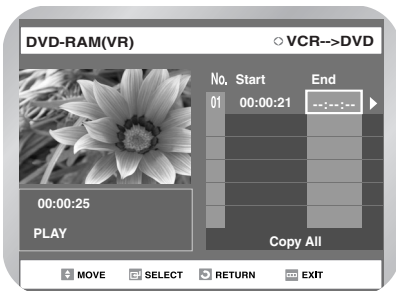

3 Select the End position in the same way.

A copylist will be generated.

- In VCR mode, the copylist cannot be saved.

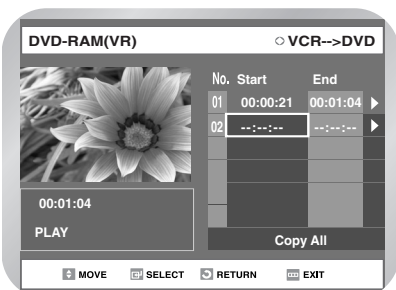

4 Press Enter button to choose the list you want to copy.

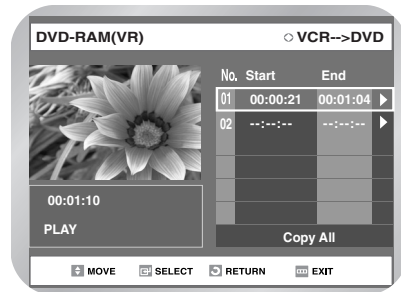

5 To copy Copylist, select "Copy".

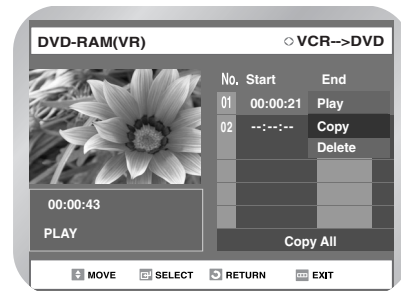

- The VCR will fast forward, searching for a start position and then automatically start a copy.
- It may not be match up with Start and END point exactly.
- If you want to copy all content, select "Copy All".

Direct copy VCR to DVD

1 Insert the VHS tape you want to copy.

2 Insert Recordable DVD disc.

3 Press DVD copy button on front panel or remote control.

4 To stop recording press the stop button.

Editing

Editing

- *Viewing the Menu Functions for a Disc* 70
- *Viewing Title List* 72
- *Playing a Title List Entry* 73
- *Renaming a Title List Entry* 74
- *Deleting a Title List Entry* 75
- *Locking a Title List Entry* 76
- *Deleting a Section from a Title List Entry* 77
- *Creating a Playlist Entry* 78
- *Editing a Playlist Entry* 80
- *Editing Scene for a Playlist Entry* . 81
- *Copying a Playlist Entry to the VCR* .. 85
- *Deleting a Playlist Entry from the Playlist* 85
- *Disc Manager* 86

Viewing the Menu Functions for a Disc



There are a variety of menu functions depending on the disc type. Press the MENU button.

No Disc

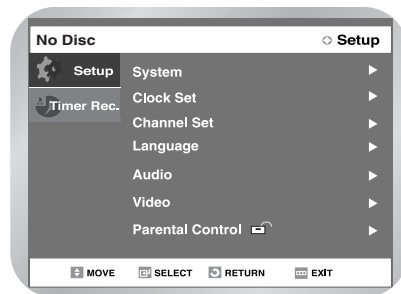

Setup
Timer Rec.

DVD-VIDEO

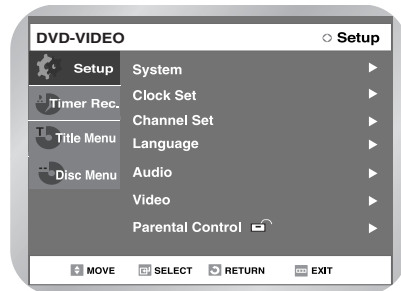

Setup
Timer Rec.
Title Menu
Disc Menu

CD

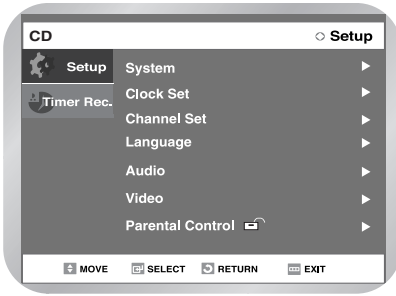

Setup
Timer Rec.

DVD-RW(VR)

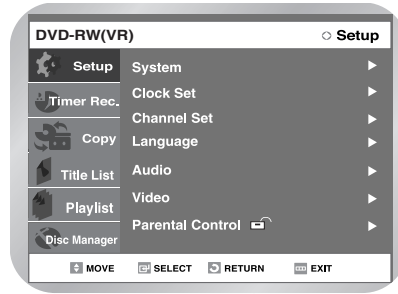

Setup
Timer Rec.
Copy
Title List
Playlist
Disc Manager

JPEG+MP3

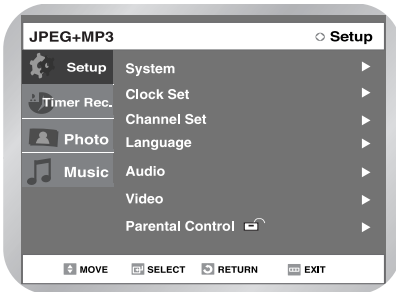

Setup
Timer Rec.
Photo
Music

DVD-R(V)

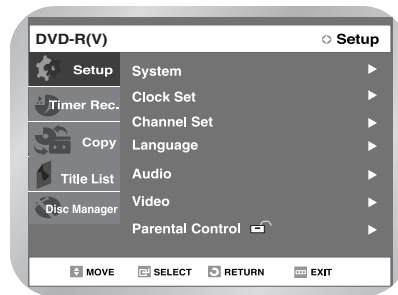

Setup
Timer Rec.
Copy
Title List
Disc Manager

DVD-RAM(VR)

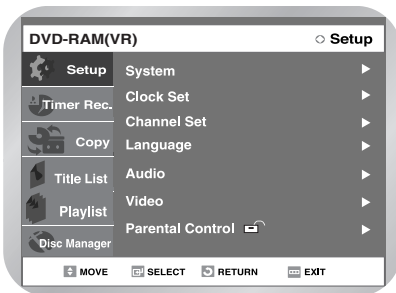

Setup
Timer Rec.
Copy
Title List
Playlist
Disc Manager



Note

- Press the MENU button again to hide the menu screen. You can configure the settings on the Setup screen using the arrow and ENTER buttons.
- If recording or editing could have been finished properly because of any kinds of error, such as sudden power failure, The recording or editing might have not been done. Please be aware that a material that has been damaged is unable retrieved to its original content.

Viewing Title List



You can playback the recorded titles, edit a title name, edit record list entries and lock or unlock the record list.

1 Press the MENU button.

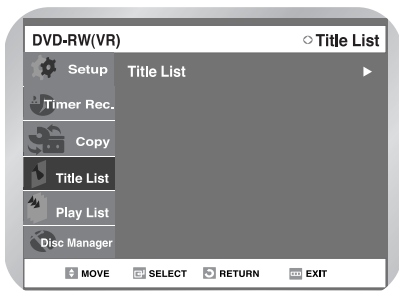
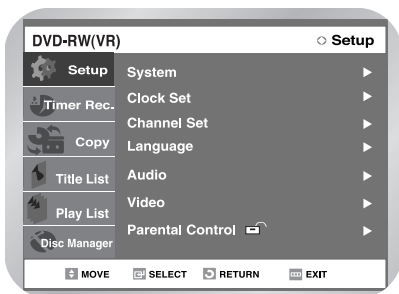

2 Press the ▲▼ button to select Title List, and then press the ENTER or ► button,
or press the TITLE button on the remote control.
• The Title List screen is displayed.

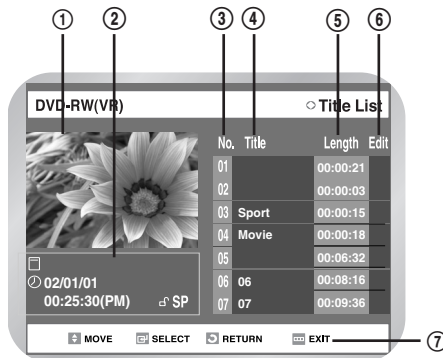

- ① Playback screen for recorded entry.
- ② Information window for the selected entry: Title name, recording date, recording time, lock status, recording mode.
- ③ Recorded entry No.
- ④ Recorded entry title.
- ⑤ Recording duration (i.e., playtime).
- ⑥ Record list edit items.
- ⑦ Button display.

Record List edit items

1 Press the ▲▼ button to select an entry to edit, and then press the ENTER or ► button.

- Play : Playbacks the selected entry.
- Rename : Renames the title of the selected entry.
- Delete : Deletes the selected entry from the list.
- Edit : Deletes a desired section.
(DVD-RAM/DVD-RW(VR mode))
- Protect : Locks or unlocks the selected entry.

2 Press the MENU button after the operation is finished. The menu screen will disappear.



■ Title List : Title refers to a recorded video stream. Title List shows a list to help you select a title. Since the title list consists of the information on data that is actually recorded, if one title is deleted, that title cannot be played again.

Playing a Title List Entry



Follow these directions to playback an entry from the Title List.

4 Press the ▲▼ button to select Play, and then press the ENTER button.

- The selected entry (title) will be played back.



Note

- You can also playback a recorded program by pressing the ANYKEY button and using the title, chapter or time items.

1 Press the MENU button.

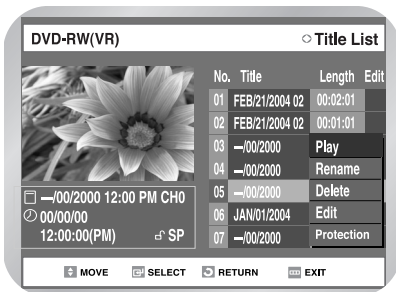

2 Press the ▲▼ button to select Title List, and then press the ENTER or ► button, or press the TITLE LIST button on the remote control.

- The View Title List screen is displayed.

3 Press the ▲▼ button to select an entry you want to playback from Title List, and then press the ENTER or ► button.

- The Edit Movie List menu is displayed.

Renaming a Title List Entry



Follow these directions to rename a title list entry, i.e., to edit the title of a recorded program.

- 1 Press the MENU button.
- 2 Press the ▲▼ button to select Title List, and then press the ENTER or ► button,
or press the TITLE LIST button on the remote control.
 - The View Title List screen is displayed.
- 3 Press the ▲▼ button to select an entry you want to rename from Title List, and then press the ENTER or ► button.
 - The Edit Title List menu is displayed.

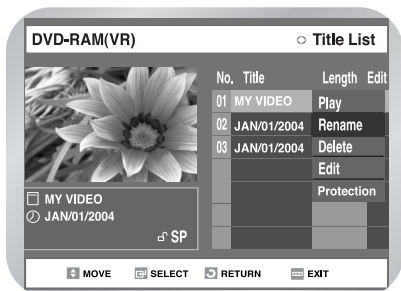

- 4 Press the ▲▼ button to select Rename, and then press the ENTER button.
 - The Rename screen is displayed.



- 5 Enter the desired characters using the arrow (▲▼ ◀▶) buttons.
 - Back Space: Moves the cursor to the previous character. (Functions the same as CLEAR)
 - Space: Enters a blank and moves the cursor to the right.
 - Delete: Deletes the character at the cursor position.
 - Clear: Deletes all the character inputs.
 - Save: Registers the character inputs.
- 6 Press the arrow buttons to select Save, and then press the ENTER button.
 - The changed title is displayed on the title item of the selected entry.

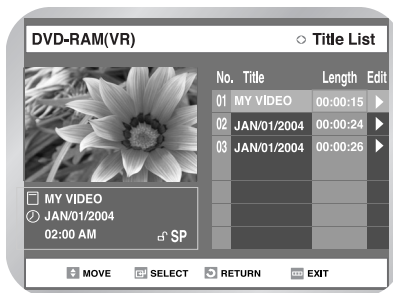

Deleting a Title List Entry



Follow these directions to delete an entry from the Title List.

1 Press the MENU button.

2 Press the ▲▼ button to select Title List, and then press the ENTER or ► button,

or press the TITLE LIST button on the remote control.

- The View Title List screen is displayed.

3 Press the ▲▼ button to select an entry you want to delete from Title List, and then press the ENTER or ► button.

- The Edit Title List menu is displayed.

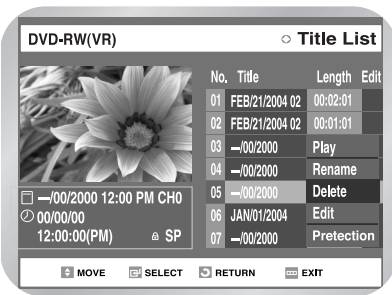

4 Press the ▲▼ button to select Delete, and then press the ENTER button.

- DVD-RAM(VR), DVD-RW(VR mode): Since Playlist is present, the message “Do you want to delete? (Related Playlist may be deleted.)” is displayed.
DVD-RW(Video mode), DVD-R: Since Playlist is not present, the message “Do you want to delete?” is displayed.
- You cannot delete a protected entry.
If you want to delete a protected entry, select “OFF” in the protection menu.

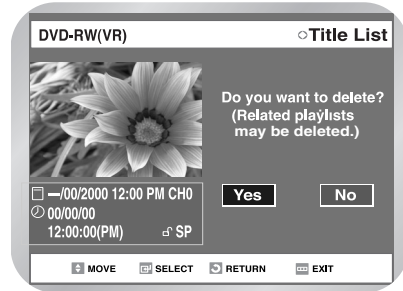

Note ■ Be careful, since you cannot recover an entry once it is deleted from Title List.

5 Press the ◀▶ button to select yes and then press the ENTER button.

Locking a Title List Entry



Follow these directions to lock an entry if you want to protect it from unexpected deletions.

- 1 Press the MENU button.
- 2 Press the ▲▼ button to select Title List, and then press the ENTER or ► button.
 - The View Title List screen is displayed.
- 3 Press the ▲▼ button to select an entry you want to protect from Title List, and then press the ENTER or ► button.
 - The Edit Title List menu is displayed.

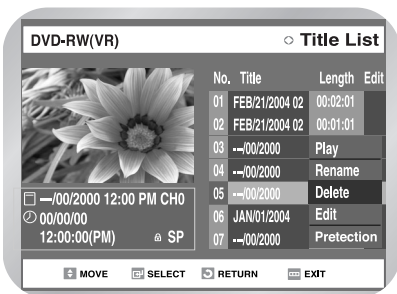

- 4 Press the ▲▼ button to select Protection, and then press the ENTER button.
 - You will be prompted with the confirmation message 'Title Protection:'.

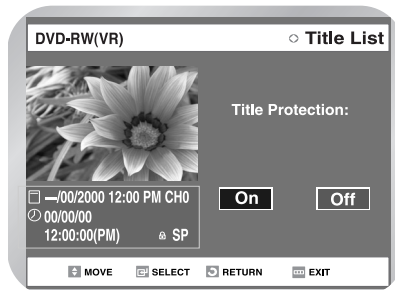

- 5 Press the ◀▶ buttons to select On, and then press the ENTER button.
 - The Lock icon on the information window for the selected entry changes to the locked status.

Deleting a Section from a Title List Entry



Follow these directions to delete a section from a Title List entry.

- 1 Press the MENU button.
 - You cannot recover a section once it is deleted from Title List.

- 2 Press the ▲▼ button to select Title List, and then press the ENTER or ► button, or press the TITLE LIST button on the remote control.
 - The View Title List screen is displayed.

- 3 Press the ▲▼ button to select an entry you want to edit from Title List, and then press the ENTER or ► button.
 - The Edit Title List menu is displayed.

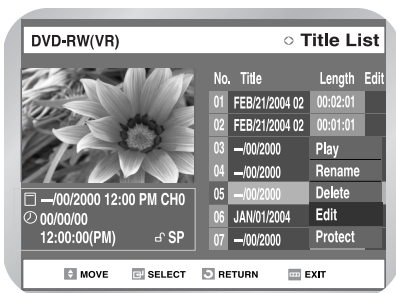

- 4 Press the ▲▼ button to select Edit, and then press the ENTER button. The Edit Program is displayed.
 - ① Playback bar
 - ② Playtime
 - ③ Section deletion start point window and time
 - ④ Section deletion end point window and time



- 5 Search the start points of the section you want to delete using the playback related buttons.
 - Playback related buttons: ►||, ◀◀, ▶▶, ◀◀, ▶▶

Note ■ Be careful, since you cannot recover a section once it is deleted from Title List.

- 6 Press the ▲▼ button to select Start, and then press the ENTER button.
 - The image and time at the start point are displayed on the start window.

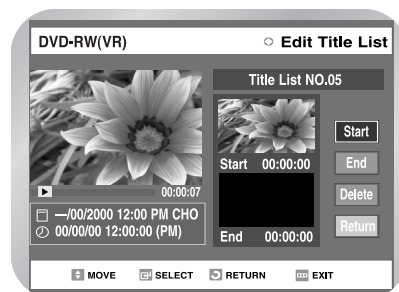

7 Press the ENTER button at the end point.

8 The image and time at the end point are displayed in the end point window.

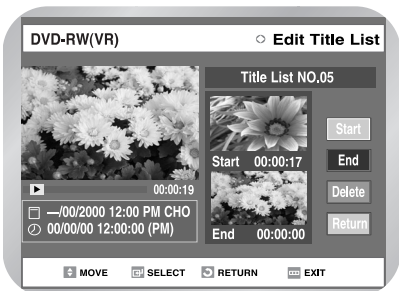

9 Press the ▲▼ buttons to select Delete, and then press the ENTER button.

- Message “Do you want to delete?” will be displayed.
- If you want to cancel, press RETURN button to return to the Title List screen.

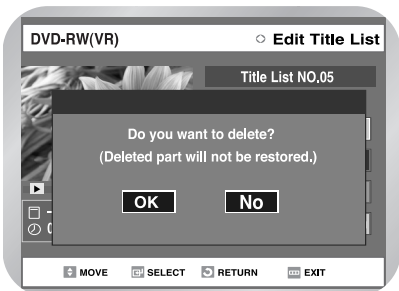

10 Press the MENU button to exit the menu after the operation is finished. The Title List screen will disappear.



Note

- The length of the selection to delete should be at least 5 seconds long.
- If the length of the section to delete is less than 5 seconds, you will be prompted with the message “The range is too short”.
- If the end time precedes the start time, you will be prompted with the message “End point cannot be marked earlier than start point”.

Creating a Playlist Entry



VR mode

Follow these directions to create a new playlist entry from a recorded title.

1 Press the MENU button when the disc is stopped.

2 Press the ▲▼ button to select Playlist, and then press the ENTER or ► button.

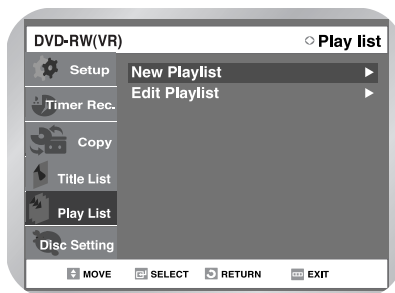

3 Press the ▲▼ button to select New Playlist, and then press the ENTER or ► button.

- The Make Scene screen is displayed.



Note

- Play List : The Playlist is a unit of playback, that is created by selecting a desired scene in the Title List. Since only the information necessary for playing a desired scene is included in a playlist, even if that playlist is deleted, the original data will not be deleted.

4 Select the start point of the section from which you want to create a new scene using the playback related buttons, and then press the PAUSE button.

- Playback related buttons: 



5 Press the  button to select Start, and then press the ENTER button.

- The image and time at the start point are displayed on the Start window.
- The yellow-colored selection bar moves to the End item.



6 Search the end point of the section from which you want to create a new scene using the playback related buttons, and then press the  button.

7 Press the ENTER button to select END point.

- The image and time at the end point are displayed on the End window.
- The yellow-colored selection bar moves to the Make item.

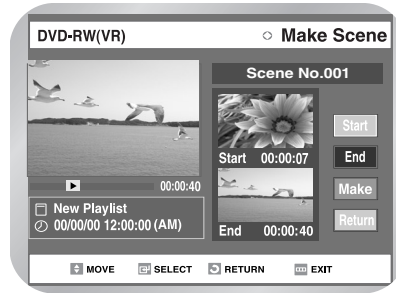

8 Press the ENTER button to confirm.

- A new make scene screen is displayed.
- Scenes to be made will be added to the current playlist.
- Repeat the above steps to make more than one scene.

9 If you want to cancel, press the  buttons to select RETURN, and then select the ENTER button.

- The Edit Playlist screen is displayed.

10 Press the MENU or RETURN button to exit the menu.

- The Playlist screen will disappear.



- You can create up to 30 playlist entries.

Editing a Playlist Entry



Follow these directions to playback or edit (rename, edit scene, copy and delete) the newly created playlist entries.

1 Press the MENU button when the disc is stopped.

2 Press the ▲▼ button to select Playlist, and then press the ENTER or ► button.

3 Press the ▲▼ button to select Edit Playlist, and then press the ENTER or ► button, or press the PLAY LIST button on the remote control.

- The Edit Playlist screen is displayed.

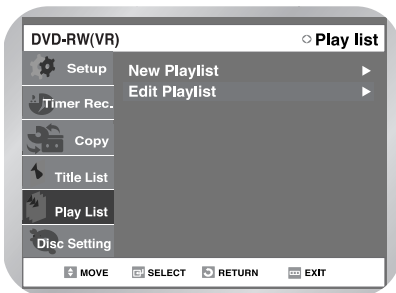

4 Press the ▲▼ button to select an entry (title) you want to edit from the Playlist, and then press the ENTER or ► button.

- The Edit Playlist menu is displayed.
:Play, Rename, Edit Scene, Copy, Delete

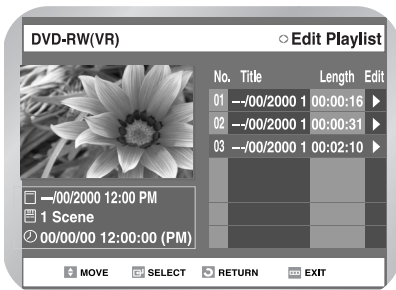

5 Press the ▲▼ button to select a function to use, and then press the ENTER button.

- **Play:** Playbacks the selected entry.
- **Rename:** Renames the title of the selected entry. Functionality is the same as the Rename item in the Edit Record List.
- The screen returns to the Edit Playlist screen. 2
- **Edit Scene:** Edits scenes of the selected entry.
- **Copy:** Copies the selected entry.
- **Delete:** Deletes the selected entry from the list.

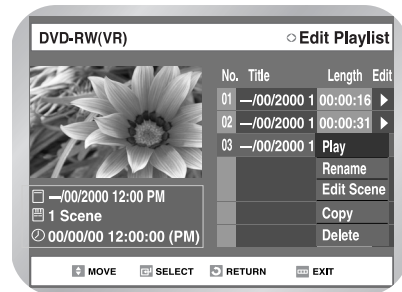

6 Press the MENU or PLAYLIST button after the operation is finished. The Playlist screen will disappear.

Playing Playlist Entries

Follow these directions to playback the playlist entries.

1 Press the ▲▼ button to select Play, and then select the ENTER button.

- The playlist entries will be played back.
- The screen returns to the Edit Playlist screen when the playback is finished.

2 Press the STOP button to stop the playback in progress.

- The screen returns to the Edit Playlist screen.

Renaming Playlist Entries

Follow these directions to rename a playlist entry, i.e., edit the title of a playlist entry.

- 1 Press the ▲▼ button to select Rename, and then press the ENTER button.
 - The Rename screen is displayed.

- 2 Select the desired characters using the arrow ▲▼◀▶ buttons.
 - Functionality is the same as the Rename item in the Edit Record List screen.

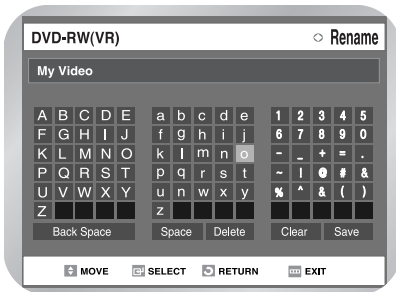

- 3 Press the arrow buttons to select save, and then press the ENTER button.
 - The Name you changed is displayed on the title item of the selected playlist entry.

Editing Scene for a Playlist Entry



VR mode

Follow these directions to edit scenes for a playlist entry.

- 1 Press the MENU button when the disc is stopped.
- 2 Press the ▲▼ button to select Playlist, and then press the ENTER or ► button.
- 3 Press the ▲▼ button to select Edit Playlist, and then press the ENTER or ► button, or press PLAY LIST button on the remote control.
 - The Edit Playlist screen is displayed.

- 4 Press the ▲▼ button to select an entry (title) you want to edit from the Playlist, and then press the ENTER or ► button.
 - The Edit Playlist menu is displayed.

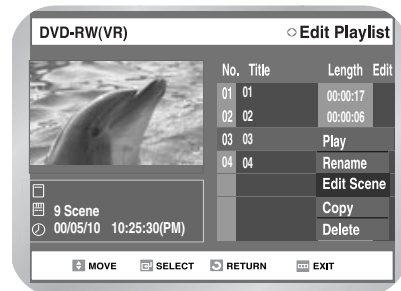

- 5 Press the ▲▼ button to select Edit Scene, and then press the ENTER button
- The Edit Scene screen is displayed.

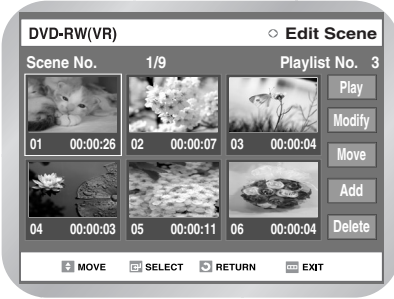

A. Playing a Desired Scene

- 1 Press the arrow buttons to select the scene you want to playback, and then press the ENTER button.
- The playlist entry to playback is selected.

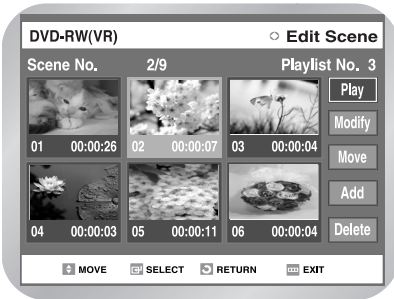

- 2 Press the ENTER button.
- The selected scene is played back.

B. Modifying a Scene (Replacing a Scene)

- 1 Press the arrow buttons to select the scene you want to modify, and then press the ENTER button.
- 2 Press the arrow buttons to select Modify, and then press the ENTER button.
- The Modify Scene screen is displayed.

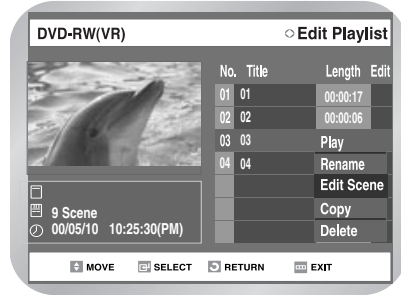

- 3 Select the start point of the section with which you want to modify the selected scene using the playback related buttons.
- Playback related buttons: ►||, ►|, ◀◀, ◀, ►►.

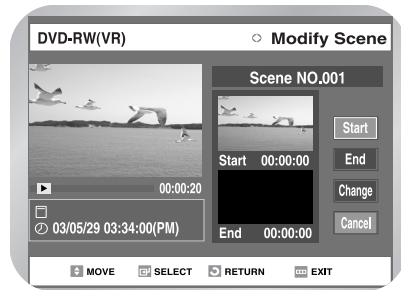

- 4 Press the ▲▼ button to select Start, and then press the ENTER button.
- The image and time at the start point are displayed on the Start window.

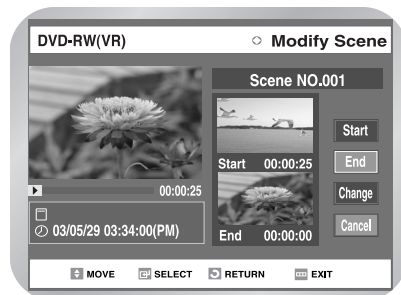

- 5 Press the ENTER button at the end point of the scene.

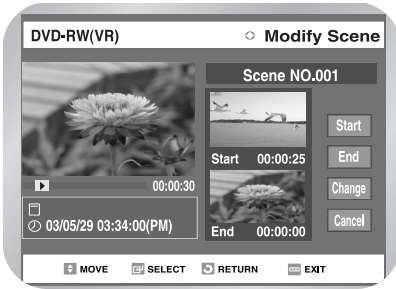

- 6 Press the ▲▼ buttons to select Change, and then press the ENTER button.
- The scene you wanted to modify is changed with the selected section.
 - If you want to cancel a modification, select cancel and then press the ENTER button.

- 3 Press the arrow buttons to select the position where you want to move the selected scene, and then press the ENTER button.

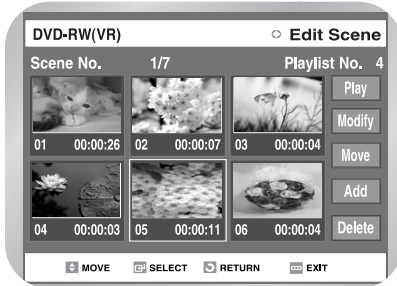

- The selected scene is moved to the new position.



- You cannot move the selected scene to the position of the next scene, because the selected scene should be inserted before that position.

C. Moving a Scene (Changing the Position of a Scene)

- 1 Press the arrow buttons to select the scene you want to move (change the position), and then press the ENTER button.
- 2 Press the ▲▼ buttons to select Move, and then press the ENTER button.
- A yellow selection window is displayed on the scene to move.

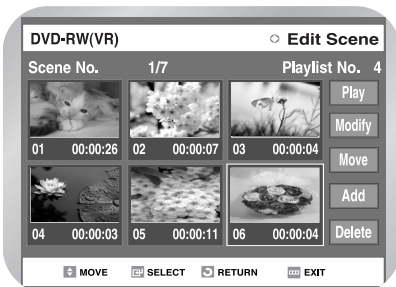

D. Adding a Scene

- 1 Press the arrow buttons to select the scene before which you want to add a new scene, and then press the ENTER button.
- A yellow selection window is displayed on the scene to add as a new scene.
- 2 Press the ▲▼ buttons to select Add and then press the ENTER button.
- The Add Scene screen is displayed.
- 3 Select the start point of the section to which you want to add the scene in step 1 using the playback related buttons.
- Playback related buttons: ►||, ►►, ◀◀, ◀◀, ►►

4 Press the ▲▼ button to select Start, and then press the ENTER button.

- The image and time at the start point are displayed on the Start window.



5 Select the end point of the section you want to add as a new scene using the playback related buttons.

6 Press the ▲▼ button to select End, and then press the ENTER button.

- The image and time at the end point are displayed on the End window.



7 Press the ▲▼ buttons to select Add, and then press the ENTER button.

- The section you wanted to add is added before the scene selected in step 1.



- If you want to cancel select cancel and then press the ENTER button.

E. Deleting a Scene from the Playlist

1 Press the arrow buttons to select the scene you want to delete, and then press the ENTER button.

2 Press the ▲▼ buttons to select delete, and then press the ENTER button.

Copying a Playlist Entry to the VCR



VR mode

- 1 Press the MENU button when the disc is stopped.
- 2 Press the ▲▼ button to select Playlist, and then press the ENTER or ► button.
- 3 Press the ▲▼ button to select Edit Playlist, and then press the ENTER or ► button, or press the PLAY LIST button on the remote control.
 - The Edit Playlist screen is displayed.

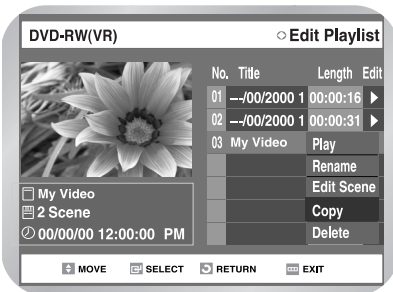

- 4 Press the ▲▼ button to select an entry(title) you want to copy to the VCR, and then press the ENTER or ► button.
 - The Edit Playlist menu is displayed.
Play, Rename, Edit Scene, Copy, Delete

- 5 Press the ▲▼ button to select Copy, and then press the ENTER button.
 - The title you choose is played and copied to VCR tape.

Deleting a Playlist Entry from the Playlist



VR mode

- 1 Press the MENU button when the disc is stopped.
- 2 Press the ▲▼ button to select Playlist, and then press the ENTER or ► button.
- 3 Press the ▲▼ button to select Edit Playlist, and then press the ENTER or ► button, or press the PLAY LIST button on the remote control.
 - The Edit Playlist screen is displayed.

- 4 Press the ▲▼ button to select an entry (title) you want to delete from the Playlist, and then press the ENTER or ► button.
 - The Edit Playlist menu is displayed.
Play, Rename, Edit Scene, Copy, Delete

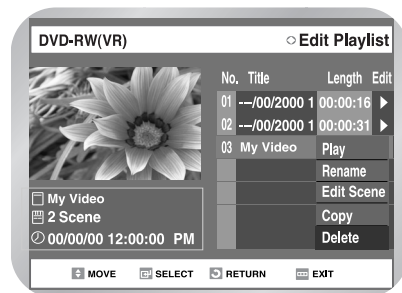

- 5 Press the ▲▼ button to select Delete, and then press the ENTER button.
- You will be prompted with the delete confirmation message 'Do you want to delete?'.

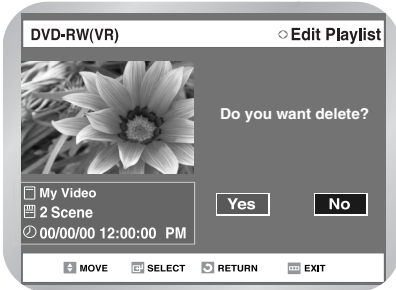

- 6 Press the ◀▶ buttons to select Yes, and then press the ENTER button.
- The screen returns to the Edit Playlist screen automatically after the delete operation finished.

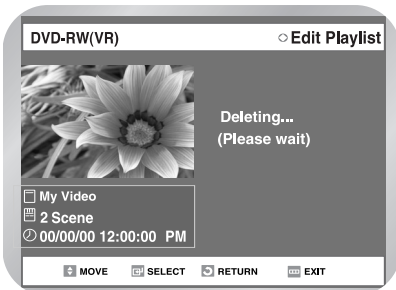

Disc Manager



Editing Disc Name

Follow these directions to give a name to a disc

- 1 Press the MENU button when the disc is stopped.
- 2 Press the ▲▼ button to select Disc Manager, and then press the ENTER or ▶ button.

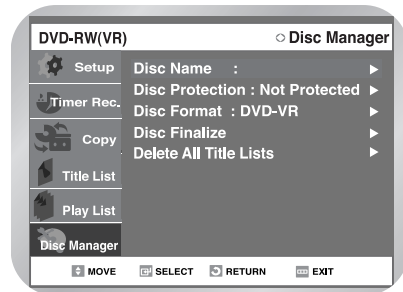

- 3 Press the ▲▼ button to select Disc Name, and then press the ENTER or ▶ button.
 - The Edit Name screen is displayed.

- 4 Enter the desired characters using the arrow buttons.

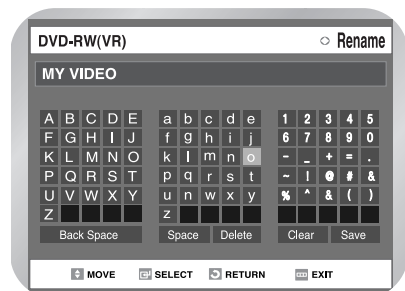

- Press the arrow buttons to select Save, and then press the ENTER button.
 - A disc name is given to the disc.

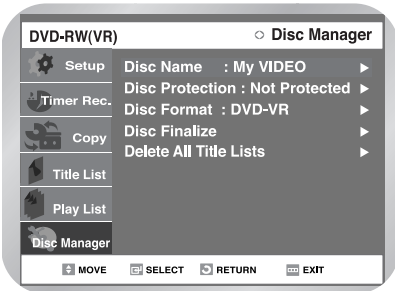

- Press the ▲▼ button to select Disc Protection, and then press the ENTER or ► button.

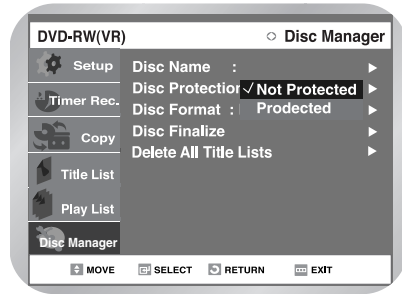

Note ■ You may need to clear cartridge protection or unlock the protect before beginning editing.

Disc Protection

Disc Protection allows you to protect your discs from disc format and program deletion due to unintended operations.

- Press the ▲▼ button to select Protected, and then press the ENTER button.

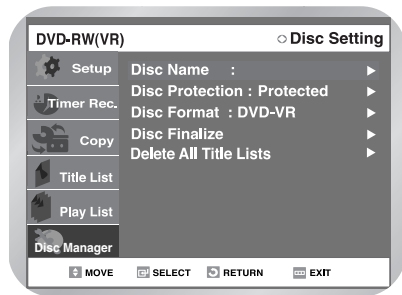

- Press the MENU button when the disc is stopped.

Note ■ Disc Protection will operate only if cartridge protect is cleared.

- Press the ▲▼ button to select Disc Manager, and then press the ENTER or ► button.

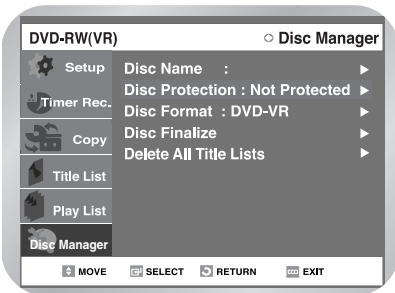

Formatting a DVD-RAM/DVD-RW Disc

Use these instructions to format a disc. The cartridge write protect tab should be set to the unprotect position. The disc protection should also be cleared.

1 Press the MENU button with the disc stopped.

2 Press the ▲▼ button to select Disc Manager, and then press the ENTER or the ► button.

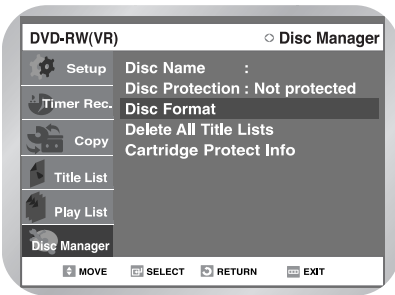

3 Press the ▲▼ button to select Disc Format, and then press the ENTER or the ► button.

- You will be prompted with the confirmation message 'Do you want to format disc?'.
- If you press ENTER you will be prompted with the confirmation message 'All data will be deleted. Do you want to continue?'.



4 Press the ◀▶ buttons to select Yes, and then press the ENTER button.

- The disc is formatted.

DVD-RW

You will be prompted with the confirmation message "Choose the recording format for DVD-RW".



DVD-VR and DVD-V are defined according to their recording format

	DVD-VR	DVD-V
Editing	Possible (Partial editing is possible)	Inconvenience
DISC	DVD-RAM DVD-RW	DVD-RW DVD-R

Delete All Title Lists



Follow these instructions to delete all title lists.

1 Press the MENU button with the disc stopped.

2 Press the ▲▼ button to select Disc Manager, and then press the ENTER or the ► button.

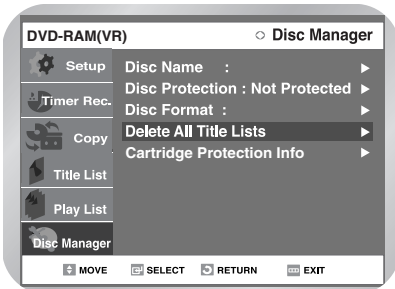

3 Press the ▲▼ button to select Delete All Title Lists, and then press the ENTER or the ► button.

- You will be prompted with the confirmation message 'Do you want to delete all title lists?'.

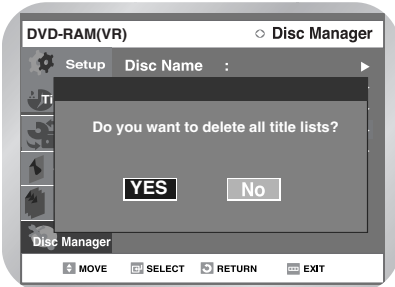

- You cannot delete a protected entry. If you want to delete a protected entry, disable Protection for it on the Lock item.
- Disc Protection: When Protected or Cartridge Protection has been set, or when a DVD-RAM is used, data cannot be deleted from a disc.

4 Press the ◀▶ buttons to select Yes, and then press the ENTER button.

- The disc is deleted.

Cartridge Protect Info (DVD-RAM)

Disc Protect allows you to protect discs from disc formatting and program deletion due to unintended operations. The cartridge write protect tab should be set to the unprotect position to be able to make a recording to a DVD-RAM disc.

1 Press the MENU button with the disc stopped.

2 Press the ▲▼ buttons to select Disc Manager, and then press the ENTER or the ► button.

3 Press the ▲▼ buttons to select Cartridge Protection Info, and then press the ENTER or the ► button.

- The cartridge protection info for the disc is displayed.

If the disc cartridge is protected, open the disc tray and check the disc.

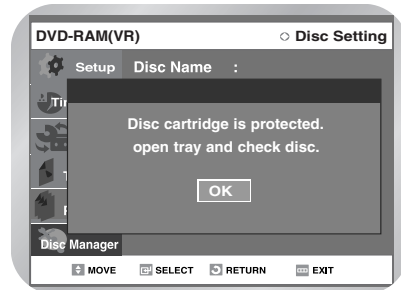

If the disc cartridge is not protected, proceed with recording to the disc.

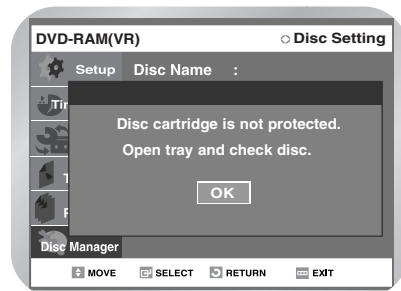

Note

- Disc Protection will operate only if cartridge protect is set to Not Protected.

Finalizing a disc



After you record titles onto a DVD-RW/DVD-R disc with your DVD Recorder-VCR, it needs to be finalized before it can be played back on external devices.



- Once a disc is finalized, you cannot delete entries from the record list.
- After being finalized, the DVD-R operates in the same manner as a DVD-Video.
- Depending on the kind of disc, the displayed screen may be slightly different.
- Finalizing will be taken few minutes. If you turn the unit on/off or open the tray during finalizing, you will not be able to use the disc anymore.

1 Press the MENU button with the disc stopped.

2 Press the ▲▼ buttons to select Disc Manager, and then press the ENTER or the ► button.

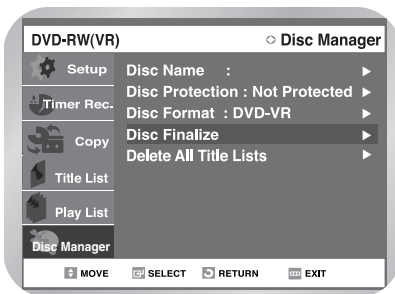

3 Press the ▲▼ button to select Disc Finalize, and then press the ENTER or the ► button.

- You will be prompted with the message 'Do you want to finalize disc?'. If you select Yes, you will be prompted again with the message 'Disc will be finalized. Do you want to continue?'



Press the ◀▶ buttons to select Yes, and then press the ENTER button.

- The disc is finalized.

Unfinalizing a disc (V/VR mode)



1 Press the MENU button with the disc stopped.

2 Press the ▲▼ button to select Disc Manager, and then press the ENTER or ► button.

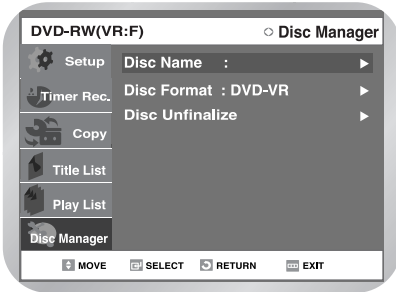

3 Press the ▲▼ button to select Disc Unfinalize, and then press the ENTER or ► button.

- You will be prompted with the message 'Do you want to unfinalize disc?'. If you select Yes, you will be prompted again with the message 'Disc will be unfinalized. Do you want to continue?'



Press the ◀▶ buttons to select Yes, and then press the ENTER button.

- The disc is unfinalized.

- A DVD-RW can be finalized or unfinalized in Video mode.

	Finalize	Unfinalize
Mark	DVD-VIDEO(RW)	DVD-RW(V)
Operation	Same as DVD-Video	Additional recording, protection and deletion are possible.

- A DVD-RW can be finalized or unfinalized in VR mode.

	Finalize	Unfinalize
Mark	DVD-RW(VR:F)	DVD-RW(VR)
Operation	Additional recording, deletion, editing, and protection are impossible.	Additional recording, deletion, editing, and protection are possible.



Reference

- *Troubleshooting (DVD-VIDEO/DVD-RAM/DVD-RW/DVD-R)* 93
- *Troubleshooting* 94
- *Problems and Solutions (VCR)* 95
- *Specifications* 96

**Troubleshooting
(DVD-VIDEO/DVD-RAM/DVD-RW/DVD-R)**



Troubleshooting



Problems and Solutions (VCR)



Specifications



**LIMITED WARRANTY TO ORIGINAL
PURCHASER**

Troubleshooting

(DVD-VIDEO/DVD-RAM/DVD-RW/DVD-R)



If your product malfunctions, go through the check points below before contacting a Samsung authorized service center,

No power.	<ul style="list-style-type: none"> • Check whether the power cord is securely plugged into the power outlet. • Did you press the power button of your DVD Recorder-VCR.
The input is displayed for a while when the power turns on.	The DVD Recorder-VCR requires some time to initialize after it is turned on.
Cannot record TV programs.	<ul style="list-style-type: none"> • Check whether the power cord is securely plugged into the power outlet. • Did you set the DVD Recorder-VCR channel settings correctly? • Check the free space on your DVD-RAM/DVD-RW/DVD-R disc. • Check the antenna cable is connected.
Timer recording does not work properly.	<ul style="list-style-type: none"> • Check the recording time, end time and current time settings again. • Recording will be cancelled, if the power is removed due to a power failure or other reason during recording.
Cannot record.	<ul style="list-style-type: none"> • Check whether the disc is formatted. This product can record on formatted discs only. (See page 88.) • Is the DVD-RAM cartridge protected? Set the write protect tab to the unprotect position. • Check whether your DVD-RAM/DVD-RW/DVD-R disc has a sufficient free space.
I pressed the REC button but there is no response.	Recording is available on DVD-RAM/DVD-RW/DVD-R discs only. If a program is copy protected, you cannot record it.
I forget the pass word for parental care.	Press the ◀◀ and ▶▶ buttons of your DVD Recorder-VCR at the same time when the power is on. All settings including password will revert to factory settings. Do not use it if not absolutely required. (Note that this function is available only when there is no disc inserted.)
Cannot playback the disc.	<ul style="list-style-type: none"> • Check whether the disc is inserted correctly with the label facing up. • Check the regional code of your DVD disc. • This DVD Recorder-VCR cannot playback some types of disc. (See page 5.)
No sound.	<ul style="list-style-type: none"> • Are you watching a program in slow or skip mode? If you are playing a program at a speed other than normal speed, sound is not output. • Check the connections and initial settings. • Check whether the disc is damaged. Clean up the disc, if necessary. • Check whether the disc is inserted correctly with the label facing up.

Troubleshooting



⊗ icon appears on the screen.	You cannot use the operation or function due to one of the following reasons: (1) Your DVD disc does not support the feature (for example, angles) (2) You've requested a title, chapter, or scan time that is out of the correct range.
Play mode settings are different from the settings configured with the Setting menu.	The disc does not support all the selected functions. In this case, some settings you configure on the Setting menu may not work properly.
Cannot change the aspect ratio.	Aspect ratio is fixed for DVD disc.
No audio output.	Check whether you selected correct digital output options in the Audio Output Options menu.
No video or audio output. The disc tray is ejected after 2 to 5 seconds.	Did you move your DVD Recorder-VCR suddenly from a cold place to a warm place? In this case, remove discs and wait for one to two hours with the power on, and then, insert the disc and try to playback again. It will work properly when condensation is removed.
Angle operation does not work during playback of a DVD disc.	Angle operation is available only when the disc contains the images captured at different angles.
The disc revolves, but no image or bad quality images are output.	<ul style="list-style-type: none">• Check whether there is damage or foreign materials on your disc.• Some discs with bad manufacturing quality may not be played back.• If the scene changes from dark to bright suddenly, the screen may jitter temporarily, but it is not a defect.
Desired sound language and subtitle language are not played.	Sound languages and subtitle languages are disc-specific. Only the sound and subtitle languages contained on a DVD disc are available and displayed on the disc menu.
No progressive (480P) output.	<ul style="list-style-type: none">• Check whether "480P" is displayed on front panel.• Make sure to change the component video output using the Progressive button when the disc is stopped.
The remote control doesn't work.	<ul style="list-style-type: none">• Point the remote control at the remote control sensor on your DVD recorder-VCR. Operate within distance. (15ft)• Remove obstacles between your DVD Recorder-VCR and remote control.• Check whether the batteries are depleted.
Other problems	<ul style="list-style-type: none">• Read the table of contents and then find and read the sections describing your problem, and follow the directions given.• Turn the unit off and on.• If your problem still persists, contact your nearest Samsung service center.

Problems and Solutions (VCR)



Before contacting a Samsung authorized service center, perform the following simple checks.

Problem	Explanation/Solution
No power	<ul style="list-style-type: none"> ◆ Check that the power plug is connected to a wall outlet. ◆ Have you pressed the POWER button?
You cannot insert a video cassette	<ul style="list-style-type: none"> ◆ A video cassette can only be inserted with the window side up and the safety tab facing you.
The television program was not recorded	<ul style="list-style-type: none"> ◆ Check the DVD Recorder-VCR antenna connections. ◆ Is the DVD Recorder-VCR tuner properly set? ◆ Check if the safety tab is intact on the cassette.
Timer recording was unsuccessful	<ul style="list-style-type: none"> ◆ Re-check the recording start/stop time settings and the current time ◆ Check whether you insert a tape which has enough time record
No playback picture or the picture is distorted	<ul style="list-style-type: none"> ◆ Check to see if you are using a prerecorded tape.
You cannot see normal broadcasts	<ul style="list-style-type: none"> ◆ Check the TUNER/EXTERNAL setting. It should be on TUNER. ◆ Check the TV antenna connections.
Noise bars or streaks on playback	<ul style="list-style-type: none"> ◆ Press the TRK (V or ^) buttons to minimize this effect.
When the ► button is pressed during playback, the still picture has severe “noise bar” streaks	<ul style="list-style-type: none"> ◆ A still picture may have “noise bars”, depending on the condition of the tape. Press the TRK (V or ^) buttons during SLOW motion to minimize this effect.
Video Head Cleaning	<ul style="list-style-type: none"> ◆ If poor pictures appear on a variety of cassettes, the video heads may need cleaning. This is not a common problem and unless it appears, the heads should not be cleaned. When cleaning the video heads, read all instructions provided with the head cleaning cassette. Incorrect head cleaning can permanently damage the video heads.

If you are unable to solve the problem after reading the above instructions, note:

- ◆ The model and serial number on the rear of your DVD Recorder-VCR
- ◆ The warranty information
- ◆ A clear description of the problem

Then contact your nearest SAMSUNG authorized service center.

Specifications



General	Power requirements	120V AC, 60Hz
	Power consumption	45 Watts
	Weight	9.03 lb
	Dimensions	16.9 in(W) x 10.6 in(D) x 3.1 in(H)
	Operating temp.	+41°F to +95°F
	Other conditions	Keep level when operating. Less than 75% operating humidity
Input	Video	1.0 V p-p at 75Ω load, sync negative S-Video input (Y: 1.0Vp-p, C: 0.286Vp-p at 75Ω load)
	Max. Audio Input Level	2Vrms
	DV Input	IEEE 1394(4p) compatible jack
	Receivable Channels	Regular TV broadcasting: VHF (2~13), UHF (14~69) Cable TV broadcasting: 1~125
Output	Audio	Audio output jacks 1, 2 Optical/Coaxial digital audio output support Min. 100 dB signal-to-noise ratio Max. 0.005% total harmonic distortion (T.H.D) • at average 1 KHz
	Video	Video output jacks 1 S-Video output 1 (Y:1.0Vp-p, C:0.286Vp-p at 75Ω load) Component output (Y: 1.0Vp-p, Pb: 0.70Vp-p, Pr: 0.70Vp-p at 75Ω load)
DVD	Picture Compression format	MPEG-II
	Audio Compression format	Dolby AC-3 256kbps
	Recording Quality	XP (about 8 Mbps), SP (about 4 Mbps), LP (about 2 Mbps), EP (about 1.2 Mbps)
	Video S/N Ratio	Min. 50dB at standard recording
	Audio S/N Ratio	Min. 75dB
	Audio frequency characteristics	20 Hz ~ 20 KHz

Audio Output

For DVD discs, audio signals recorded at 96kHz sampling frequency are converted into and output at 48kHz digital output.

Disc Type	DVD	AUDIO CD(CDDA)
Analog Audio Output	48 / 96KHz	44.1KHz
Digital Audio Output	48KHz	44.1KHz



ELECTRONICS

Samsung Limited Warranty

Samsung Electronics Canada Inc. (SECA), warrants that this product is free from defective material and workmanship.

SECA further warrants that if this product fails to operate properly within the specified warranty period and the failure is due to improper workmanship or defective material SECA will repair or replace the product at its option.

All warranty repairs must be performed by a SECA authorized service centre. (The name and address of the location nearest you can be obtained by calling toll free **1-800-268-1620** or visiting our web site at **www.samsung.ca**)

Labour	Parts
one (1) year (carry-in)	one (1) year

On carry-in models, transportation to and from the service centre is the customer's responsibility.

The original dated sales receipt must be retained by the customer and is the only acceptable proof of purchase. It must be presented to the authorized service centre at the time service is requested.

Exclusions

This warranty does not cover damage due to accident, fire flood and/or other acts of God; misuse, incorrect line voltage, improper installation, improper or unauthorized repairs, commercial use, or damage that occurs in shipping. Exterior and interior finish, lamps and glass are not covered under this warranty. Customer adjustments which are explained in the instruction manual are not covered under the terms of this warranty. This warranty will automatically be voided for any unit found with a missing or altered serial number. This warranty is valid only on products purchased and used in Canada.